

IMPORTANT
READ CAREFULLY BEFORE USE
KEEP SAFE TO CONSULT AT A LATER DATE



MADE
IN
GERMANY

Translation of original operating instructions for
KETTLER pedelegs with BOSCH KIOX
on-board computer



BOSCH



Quadriga

Comp Belt CX5, Comp CX11 750, Pro Belt Automatic, Pro CX12 750, Town & Country COMP 750,
Town & Country Pro 750

KB180-xxFD, KB180-xxFW, KB181-xxKD, KB181-xxKW, KB182-xxKD, KB182-xxKW, KB183-xxKD,
KB183-xxKW, KB184-xxKD, KB184-xxKT, KB184-xxKW, KB185-xxFD, KB185-xxFW

Contents

1	About these operating instructions	
1.1	Manufacturer	10
1.2	Laws, standards and directives	10
1.3	Language	10
1.4	For your information	10
1.4.1	Warnings	10
1.4.2	Markups	10
1.5	Type number and model	11
1.6	Frame number	11
1.7	Identifying the operating instructions	11
1.8	Aim of the operating instructions	12
2	Safety	
2.1	Residual risks	13
2.1.1	Risk of fire and explosion	13
2.1.1.1	Rechargeable battery	13
2.1.1.2	Overheated charger	13
2.1.1.3	Hot components	13
2.1.2	Electric shock	14
2.1.2.1	Damage	14
2.1.2.2	Water penetration	14
2.1.2.3	Condensation	14
2.1.3	Risk of a crash	14
2.1.3.1	Incorrect quick release setting	14
2.1.3.2	Incorrect tightening torque	14
2.1.3.3	Incorrect component	14
2.1.4	Risk of amputation	14
2.1.5	Key breaking off	14
2.1.6	Malfunctions due to Bluetooth®	15
2.1.7	Data privacy information	15
2.2	Toxic substances	16
2.2.1	Brake fluid	16
2.2.2	Defective battery	16
2.3	Requirements for the rider	16
2.4	Vulnerable groups	16
2.5	Personal protective equipment	16
2.6	Safety guards	16
2.7	Safety markings and safety instructions	17
2.8	What to do in an emergency	17
2.8.1	Dangerous situation in road traffic	17
2.8.2	Leaked brake fluid	17
2.8.3	Battery vapours emitted	18
2.8.4	Battery fire	18
3	Description	
3.1	Proper use	19
3.1.1	Improper use	20
3.1.2	Permitted total weight (PTW)	21
3.1.3	Environmental requirements	22
3.2	Nameplate	24
3.3	Components	25
3.3.1	Overview	25
3.3.2	Chassis	26
3.3.2.1	Frame	26
3.3.2.2	Steering system	26

3.3.2.3	Steering headset	26
3.3.2.4	Stem	26
3.3.2.5	Handlebars	27
3.3.2.6	Fork	27
3.3.3	Suspension	28
3.3.3.1	Rigid fork	28
3.3.3.2	Suspension fork	28
3.3.4	Wheel	32
3.3.4.1	Tyres	32
3.3.4.2	Rim	32
3.3.4.3	Valve	32
3.3.4.4	Spoke	33
3.3.4.5	Spoke nipples	33
3.3.4.6	Hub	33
3.3.5	Braking system	34
3.3.5.1	Mechanical brake	34
3.3.5.2	Hydraulic brake	34
3.3.5.3	Disc brake	35
3.3.6	Seat post	36
3.3.6.1	Patent seat post	36
3.3.6.2	Suspension seat post	36
3.3.7	Mechanical drive system	37
3.3.7.1	Chain drive layout	37
3.3.7.2	Belt drive layout	37
3.3.8	Electric drive system	38
3.3.8.1	Motor	38
3.3.8.2	Rechargeable battery	38
3.3.8.3	Charger	39
3.3.8.4	Lighting	39
3.3.8.5	Integrated battery	39
3.3.9	On-board computer	40
3.3.9.1	Display	40
3.4	Description of controls and screens	41
3.4.1	Handlebars	41
3.4.2	Control panel	42
3.4.2.1	System message	43
3.4.2.2	Creating a user account	44
3.4.2.3	Software updates	44
3.4.2.4	Activity tracking	44
3.4.2.5	Lock function	44
3.4.3	Display	45
3.4.3.1	START SCREEN	45
3.4.3.2	Status screen	46
3.4.3.3	Settings	46
3.4.4	Battery level indicator (battery)	47
3.4.5	Gear shift	48
3.4.5.1	SHIMANO SW-E7000 derailleur gears	48
3.4.6	Fork lock	49
3.4.6.1	SR Suntour	49
3.4.7	Hand brake	50
3.5	Technical data	51
3.5.1	Pedelec	51
3.5.2	Emissions	51
3.5.3	Bicycle lighting	51
3.5.4	Display mount	51
3.5.5	LED Remote on-board computer	51
3.5.6	BOSCH Kiox300 display	51
3.5.7	BOSCH Performance Line CX motor	51
3.5.8	BOSCH PowerTube 750 battery	52

3.5.9	Tightening torques	53
4	Transporting and storing	
4.1	Weight and dimensions for transportation	55
4.2	Designated handles, lifting points	55
4.3	Transportation	56
4.3.1	Using the transport securing system	56
4.3.2	Transporting the pedelec	56
4.3.3	Shipping a pedelec	56
4.3.4	Transporting the battery	56
4.3.5	Shipping the battery	56
4.4	Storing	57
4.4.1	Break in operation	57
4.4.1.1	Preparing a break in operation	57
4.4.1.2	Carrying out a break in operation	57
5	Assembly	
5.1	Unpacking	58
5.2	Required tools	58
5.3	Commissioning	59
5.3.1	Checking the battery	59
5.3.1.1	Securing the PowerTube BS3 battery mount	60
5.3.2	Preparing the wheel	61
5.3.3	Installing the wheel in the SUNTOUR fork	62
5.3.3.1	Screw-on axle (12AH2 and 15AH2)	62
5.3.3.2	20 mm cross axle	63
5.3.3.3	Q-LOC quick release	65
5.3.4	Fitting the pedals	66
5.3.5	Preparing the LIMOTEC seat post	67
5.3.6	Checking the stem and handlebars	68
5.3.6.1	Checking the connections	68
5.3.6.2	Checking stem is firmly in position	68
5.3.6.3	Checking the headset backlash	68
5.4	Pedelec sale	68
6	Operation	
6.1	Risks and hazards	69
6.2	Tips for a greater range	71
6.3	Error message	72
6.3.1	On-board computer	72
6.3.1.1	Less critical errors	72
6.3.1.2	Critical errors	72
6.3.2	Rechargeable battery	72
6.4	Instruction and customer service	73
6.5	Adjusting the pedelec	73
6.5.1	Preparing	73
6.5.2	Pedelec adjustment procedure	74
6.5.3	Determining the sitting position	75
6.5.4	Adjusting the saddle	77
6.5.4.1	Straightening the saddle	77
6.5.4.2	Adjusting the saddle height	77
6.5.4.3	Setting the saddle height with the remote control	78
6.5.4.4	Adjusting the saddle position	79
6.5.4.5	Adjusting the saddle tilt	79
6.5.4.6	Checking saddle stability	79
6.5.5	Handlebars	80
6.5.5.1	Handlebar width	80
6.5.5.2	Hand position	80

6.5.5.3	Adjusting the handlebars	80
6.5.6	Stem	81
6.5.6.1	Adjusting the handlebar height with quick release	81
6.5.6.2	Setting the quill stem	82
6.5.6.3	Adjusting the Ahead stem	82
6.5.6.4	Adjusting the angle-adjustable stem	83
6.5.7	Ergonomic handles	84
6.5.7.1	Checking handlebar stability	84
6.5.8	Tyres	85
6.5.9	Brake	86
6.5.9.1	Brake handle position	86
6.5.9.2	Brake handle tilt angle	86
6.5.9.3	Determining the grip distance	87
6.5.9.4	Retracting the brake linings	88
6.5.10	Tyres	89
6.5.10.1	Grip distance on a SHIMANO ST-EF41 brake lever	90
6.5.10.2	Grip distance on a SHIMANO ST-EF41 brake lever	91
6.5.11	Suspension	92
6.5.12	Fork sag	92
6.5.12.1	Adjusting the Suntour fork steel suspension	93
6.5.12.2	Adjusting the Suntour fork air suspension	94
6.5.13	Fork rebound damping	95
6.5.13.1	Adjusting the Suntour fork rebound damping	96
6.5.14	Lighting	97
6.5.14.1	Adjusting the lights	97
6.5.15	On-board computer	99
6.5.15.1	Creating a user account	99
6.5.15.2	Connecting the on-board computer with the smartphone	99
6.5.15.3	Update software	99
6.5.15.4	Activating activity tracking	99
6.5.15.5	Setting up the lock function (optional)	99
6.5.15.6	Inserting the display	100
6.5.15.7	Securing the on-board computer (optional)	100
6.5.15.8	Removing the on-board computer	100
6.5.15.9	Adjust on-board computer	101
6.5.15.10	Adjust on-board computer	102
6.5.15.11	Selects the language	102
6.5.15.12	Adjusting the clock	102
6.5.15.13	Adjusting the time format	102
6.5.15.14	Selecting units	102
6.5.15.15	Setting the brightness	102
6.5.15.16	Reset settings	103
6.6	Accessories	104
6.6.1	Child seat	104
6.6.2	Trailer	105
6.6.2.1	Approval for trailer with Enviolo hub	105
6.6.2.2	Approval for trailer with ROHLOFF hub	106
6.6.3	Mobile holder	106
6.6.4	Tubeless and airless tyres	106
6.6.5	Suspension fork coil spring	106
6.6.6	Pannier rack	106
6.6.7	Panniers and cargo boxes	106
6.7	Personal protective equipment and accessories for road safety	107
6.8	Before each ride	107
6.9	Straightening the quickly adjustable stem	108
6.10	Using the pannier rack	108
6.11	Raising the kickstand	109
6.12	Using the saddle	109
6.12.1	Using the leather saddle	109

6.13	Using the pedals	109
6.14	Using the multifunctional handlebars or bar ends	109
6.14.1	Using leather handles	109
6.15	Using the bell	109
6.16	Using the battery	110
6.16.1	Removing the battery	110
6.16.1.1	Inserting the battery	110
6.16.2	Charging the battery	111
6.17	Using pedelec with the electric drive system	112
6.17.1	Switching on the electric drive system	112
6.17.2	Switching off the electric drive system	112
6.18	Using the on-board computer	113
6.18.1	Using the diagnosis port	113
6.18.2	Charging the control panel battery	113
6.18.3	Using the riding light	114
6.18.4	Setting the brightness of indicators	114
6.18.5	Using the push assist system	114
6.18.6	Selecting the level of assistance	115
6.19	Brake	116
6.19.1	Using the brake lever	116
6.20	Gear shift	117
6.20.1	Using the derailleur gears	117
6.21	Suspension and damping	118
6.21.1	Adjusting the Suntour compression adjuster	119
6.22	Parking	120
6.22.1	Screwing in the quickly adjustable stem	121
6.22.2	Activating the lock function	122

7 Cleaning, servicing and maintenance

7.1	Before each ride	127
7.1.1	Checking the guards	127
7.1.2	Checking the frame	127
7.1.3	Checking the fork	127
7.1.4	Checking the rear frame damper	127
7.1.5	Checking the pannier rack	127
7.1.6	Checking the guards	127
7.1.7	Checking wheel concentricity	127
7.1.8	Checking the quick releases	127
7.1.9	Checking the suspension seat post	127
7.1.10	Checking the bell	128
7.1.11	Checking the handles	128
7.1.12	Checking the USB cover	128
7.1.13	Checking the lighting	128
7.1.14	Checking the brake	128
7.2	After each ride	129
7.2.1	Cleaning the lights and reflectors	129
7.2.2	Cleaning the suspension fork	129
7.2.3	Caring for the suspension fork	129
7.2.4	Cleaning the pedals	129
7.2.5	Cleaning the brake	129
7.2.6	Cleaning the suspension seat post	129
7.2.7	Cleaning the rear frame damper	129
7.3	Basic cleaning	130
7.3.1	On-board computer and control panel	130
7.3.2	Rechargeable battery	130
7.3.3	Motor	130
7.3.4	Frame, fork, pannier rack, guards and kickstand	131
7.3.5	Stem	131
7.3.6	Handlebars	131

7.3.7	Handles	131
7.3.7.1	Leather handles	131
7.3.8	Seat post	131
7.3.9	Saddle	131
7.3.9.1	Leather saddle	132
7.3.10	Tyres	132
7.3.11	Spokes and spoke nipples	132
7.3.12	Hub	132
7.3.13	Switching elements	132
7.3.13.1	Shifter	132
7.3.14	Cassette, chain wheels and front derailleur	132
7.3.15	Brake	133
7.3.15.1	Brake lever	133
7.3.16	Brake disc	133
7.3.17	Belt	133
7.3.18	Chain	133
7.3.18.1	Chain with all-round chain guard	133
7.4	Servicing	134
7.4.1	Frame	134
7.4.2	Fork	134
7.4.3	Pannier rack	135
7.4.4	Mudguard	135
7.4.5	Servicing the kickstand	135
7.4.6	Stem	135
7.4.7	Handlebars	135
7.4.8	Handle	135
7.4.8.1	Rubber handles	135
7.4.8.2	Leather handle	135
7.4.9	Seat post	136
7.4.9.1	Suspension seat post	136
7.4.9.2	Carbon seat post	136
7.4.10	Rim	136
7.4.11	Leather saddle	136
7.4.12	Hub	136
7.4.13	Spoke nipples	136
7.4.14	Gear shift	137
7.4.14.1	Rear derailleur articulated shafts and jockey wheels	137
7.4.14.2	Shifter	137
7.4.15	Pedal	137
7.4.16	Caring for the chain	137
7.4.16.1	Caring for the chain and all-round chain guard	138
7.4.17	Caring for the battery	138
7.4.18	Caring for the brake	138
7.4.18.1	Caring for the brake	138
7.4.19	Lubricating the Eightpins seat post tube	138
7.5	Maintenance	139
7.5.1	Wheel	139
7.5.1.1	Checking the tyre pressure	139
7.5.1.2	Checking the tyres	141
7.5.1.3	Checking the rims	142
7.5.1.4	Checking the nipple holes	142
7.5.1.5	Checking the nipple well	142
7.5.1.6	Checking the rim hooks	142
7.5.1.7	Checking the spokes	142
7.5.2	Checking the brake system	143
7.5.2.1	Checking the hand brake	143
7.5.2.2	Checking the hydraulic system	143
7.5.2.3	Checking the Bowden cables	143
7.5.2.4	Checking the disc brake	144

7.5.2.5	Checking the back-pedal brake	145
7.5.2.6	Checking the rim brake	146
7.5.3	Checking the lighting	147
7.5.4	Checking the stem	148
7.5.5	Check the handlebars	148
7.5.6	Checking the saddle	148
7.5.7	Checking the seat post	148
7.5.8	Checking the chain	148
7.5.9	Checking the chain and belt tension	148
7.5.9.1	Checking the derailleur gears	149
7.5.9.2	Checking the hub gear	149
7.5.10	Checking the gear shift	149
7.5.10.1	Electric gear shift	149
7.5.10.2	Mechanical gear shift	149
7.5.10.3	Checking the derailleur gears	149
7.5.11	Adjusting gear shift	150
7.5.11.1	ROHLOFF hub	150
7.5.12	Bowden-cable-operated gear shift, single-cable	150
7.5.13	Bowden-cable-operated gear shift, dual-cable	150
7.5.14	Bowden-cable-operated twist grip, dual-cable	151
7.5.15	Checking kickstand stability	151

8 Maintenance

8.1	Initial inspection	152
8.2	Maintenance	152
8.3	Component-specific maintenance tasks	152
8.4	Carry out initial inspection	155
8.5	Maintenance instructions	156
8.5.1	Servicing the frame	163
8.5.1.1	Servicing the carbon frame	163
8.5.2	Checking the pannier rack	163
8.5.3	Servicing axle with quick release	163
8.5.4	Maintaining the stem	164
8.5.5	Servicing the gear hub	164
8.5.5.1	Adjusting the hub with cone bearing	164
8.5.6	Servicing the steering headset	165
8.5.7	Servicing the fork	165
8.5.7.1	Servicing the carbon suspension fork	166
8.5.7.2	Servicing the suspension fork	166
8.5.8	Servicing seat post	167
8.5.8.1	Servicing the carbon seat post	167
8.5.8.2	by.schulz suspension seat post	168
8.5.8.3	Suntour suspension seat post	168
8.5.8.4	eightpins NGS2 seat post	169
8.5.8.5	eightpins H01 seat post	175
8.5.9	Rear frame damper	179
8.5.9.1	FOX component-specific maintenance	180

9 Troubleshooting, fault clearance and repair

9.1	Troubleshooting and fault clearance	181
9.1.1	Drive system or on-board computer does not start up	181
9.1.2	Errors in assistance function	182
9.1.3	Battery errors	183
9.1.4	Display screen errors	184
9.1.5	Lighting does not work	184
9.1.6	Other errors	185
9.1.7	Suntour suspension fork	186
9.1.7.1	Rebound too fast	186
9.1.7.2	Rebounding too slowly	187

9.1.7.3	Suspension too soft on inclines	188
9.1.7.4	Excessively hard damping on bumps	189
9.1.8	Rear frame damper	190
9.1.8.1	Rebound too fast	190
9.1.8.2	Rebounding too slowly	191
9.1.8.3	Suspension too soft on inclines	192
9.1.8.4	Excessively hard damping on bumps	193
9.2	Repair	194
9.2.1	Original parts and lubricants	194
9.2.2	Replacing the lighting	194
9.2.3	Setting the front light	194
9.2.4	Checking tyre clearance	194
9.2.5	Replacing pedelec components if lock function is installed	195
9.2.5.1	Replacing a smartphone	195
9.2.5.2	Replacing the on-board computer	195
9.2.5.3	Activating the lock function after motor replacement	195
10	Recycling and disposal	
10.1	Removal of waste guidelines	196
11	Documents	
11.1	Assembly report	198
11.2	Maintenance log	200
11.3	Parts list	204
11.3.1	QUADRIGA COMP BELT CX5	204
11.3.2	QUADRIGA COMP CX11 750	206
11.3.3	QUADRIGA PRO BELT AUTOMATIC	208
11.3.4	QUADRIGA PRO CX12 750	210
11.3.5	QUADRIGA TOWN & COUNTRY COMP 750	212
11.3.6	QUADRIGA TOWN & COUNTRY PRO 750	214
11.4	Charger operating instructions	216
12	Glossary	
12.1	Abbreviations	226
12.2	Simplified terms	226
13	Appendix	
I.	Translation of the original EC/EU Declaration of Conformity	227
II.	Declaration of conformity with RED Directive	228
14	Keyword index	

Thank you for your trust!

KETTLER *pedelecs* are premium quality vehicles. You have made an excellent choice. Your specialist dealer will provide you with guidance and instruction and assemble your product. Your specialist dealer will also be happy to assist you in the future, whether you require maintenance, conversion or repair.

You are receiving these operating instructions with your new pedelec. Please take time to become familiar with your new pedelec. Use the tips and suggestions in the operating instructions. They will help you to enjoy your pedelec for a long time to come. We hope you have fun and wish you well on all of your rides!

Download the operating instructions onto your phone at the following link, so that you can use them when you are out riding:



<https://www.kettler-alu-rad.de/gb/en/index/service.html>.

Copyright

© KETTLER Alu-Rad GmbH

Distribution or reproduction of these operating instructions and utilisation or communication of their content is prohibited unless expressly approved. Any infringement will render the offender liable for compensation. All rights reserved in the event that a patent, utility model or industrial design is registered.

Subject to internal changes

The information contained in these *operating instructions* are the approved technical specifications at the time of printing. In addition to the functions described here, software changes may be introduced to rectify errors and extend functions at any time.

Any significant changes are included in a new published version of the operating instructions. All changes to the operating instructions are published on the following website:

<https://www.kettler-alu-rad.de/gb/en/index/service.html>

Editing

Text and images:
ZEG Zweirad-Einkaufs-Genossenschaft eG
Longericher Strasse 2
50739 Köln, Germany

Translation

RKT Übersetzungs- und Dokumentations-GmbH
Bahnhofstrasse 27
78713 Schramberg, Germany

In case of any questions or problems regarding these operating instructions, please contact:

tecdoc@zeg.de

1 About these operating instructions

1.1 Manufacturer

KETTLER Alu-Rad GmbH
Longericher Strasse 2
50739 Köln, Germany

Tel.: +49 6805 6008-0
Fax: +49 6805 6008-3098
E-mail: info@kettler-alu-rad.de

1.2 Laws, standards and directives

The *operating instructions* comply with the essential requirements specified in:

- Machinery Directive 2006/42/EC
- Electromagnetic Compatibility Directive 2014/30/EU
- ISO 20607:2018 Safety of machinery – Instruction handbook – General drafting principles
- EN 15194:2018 Cycles – Electrically power assisted cycles – pedelec bicycles
- EN 11243:2016, Cycles – Pannier racks for bicycles – Requirements and test methods
- ISO 17100:2016-05 Translation Services – Requirements for translation services.

1.3 Language

The *original operating instructions* are written in German. A translation is invalid without the *original operating instructions*.

1.4 For your information

Different markings are used in the operating instructions to make them easier to read.

1.4.1 Warnings

Warnings indicate hazardous situations and actions. You will find three warnings in the operating instructions:



WARNING

May lead to serious or even fatal injuries if ignored. Medium-risk hazard.



CAUTION

May lead to minor or moderate injuries if ignored. Low-risk hazard.

Notice

May lead to material damage if ignored.

1.4.2 Markups

You will find ten text markups in the *operating instructions*:

Stylised form	Use
<i>Italics</i>	Glossary term, first mention in section
<u>Underlined in blue</u>	Link
<u>Underlined in grey</u>	Cross references
✓	Requirements
▶	Instructions for actions without specific order
1	Instructions for actions in specified order
⇒	Result of the actions
BLOCKED	Indicators on the display screen
•	Bulleted lists
Only applies to pedelecs with this equipment	A note beneath the heading indicates components which can be used as an option.

Table 1: Markups

1.5 Type number and model

These operating instructions are an integral part of pedelecs with the type numbers:

Type no.	Model	Pedelec type
KB180-xxFD	Quadriga Pro Belt Automatic, Diamant	City and trekking bicycle
KB180-xxFT	Quadriga Pro Belt Automatic, Trapez	City and trekking bicycle
KB180-xxFW	Quadriga Pro Belt Automatic, Wave	City and trekking bicycle
KB181-xxKD	Quadriga Pro CX12, Diamant	City and trekking bicycle
KB181-xxKT	Quadriga Pro CX12, Trapez	City and trekking bicycle
KB181-xxKW	Quadriga Pro CX12, Wave	City and trekking bicycle
KB182-xxKD	Quadriga Town & Country Pro, Diamant	City and trekking bicycle
KB182-xxKT	Quadriga Town & Country Pro, Trapez	City and trekking bicycle
KB182-xxKW	Quadriga Town & Country Pro, Wave	City and trekking bicycle
KB183-xxKD	Quadriga Town & Country COMP, Diamant	City and trekking bicycle
KB183-xxKT	Quadriga Town & Country COMP, Trapez	City and trekking bicycle
KB183-xxKW	Quadriga Town & Country COMP, Wave	City and trekking bicycle
KB184-xxKD	Quadriga Comp CX11, Diamant	City and trekking bicycle
KB184-xxKT	Quadriga Comp CX11, Trapez	City and trekking bicycle
KB184-xxKW	Quadriga Comp CX11, Wave	City and trekking bicycle
KB185-lxxD	Quadriga Comp Belt CX5, Diamant	City and trekking bicycle
KB185-lxxT	Quadriga Comp Belt CX5, Trapez	City and trekking bicycle
KB185-lxxW	Quadriga Comp Belt CX5, Wave	City and trekking bicycle

Table 2: Type number, model and pedelec type

1.6 Frame number

Each frame has an individual frame number stamped on it (see Figure 2). The frame number can be used to associate the pedelec with the owner. The frame number is the most important identifier for verifying ownership.

1.7 Identifying the operating instructions

The operating instructions identification number is located in bottom left-hand corner of each page.

The identification number is composed of the document number, the version number and the release date.

Identification number	MY22K0a - 62_1.0_30.11.2021
------------------------------	-----------------------------

1.8 Aim of the operating instructions

These operating instructions are not a substitute for personal instruction by the specialist dealer supplying the bike. These operating instructions are an integral part of the pedelec. Therefore, if it is re-sold at a later time, they must be handed over to the subsequent owner.

These operating instructions are mainly designed for riders and operators of the pedelec.

Paragraphs with a white background are intended to enable non-professionals to make safe settings on the pedelec, use it, clean it and identify and eliminate any faults.



Sections intended for technical staff are highlighted in blue and marked with a spanner symbol.

These paragraphs aim to allow trained technical staff (bicycle mechatronics engineers, bicycle mechanics or similar) to carry out initial assembly, adjustment, maintenance and repair safely.

Technical staff also need to read all sections for riders and operators to ensure they can provide a better customer service.

All documents in Section 11 need to be filled out whenever any work is performed on the vehicle (assembly report, maintenance report).

Section		Rider	Specialist dealer
1	About these instructions	<input type="checkbox"/>	<input type="checkbox"/>
2	Safety	<input type="checkbox"/>	<input type="checkbox"/>
3	Description	<input type="checkbox"/>	<input type="checkbox"/>
4	Transportation and storage	<input type="checkbox"/>	<input type="checkbox"/>
5	Assembly and installation	<input type="checkbox"/>	<input type="checkbox"/>
6	Operation	<input type="checkbox"/>	<input type="checkbox"/>
7	Cleaning and servicing	<input type="checkbox"/>	<input type="checkbox"/>
8	Maintenance	<input type="checkbox"/>	<input type="checkbox"/>
9.1	Troubleshooting and fault clearance	<input type="checkbox"/>	<input type="checkbox"/>
9.2	Repair	<input type="checkbox"/>	<input type="checkbox"/>
10	Disassembly and disposal	<input type="checkbox"/>	<input type="checkbox"/>
11	Documents	<input type="checkbox"/>	<input type="checkbox"/>
12	Glossary	<input type="checkbox"/>	<input type="checkbox"/>
13	Appendix	<input type="checkbox"/>	<input type="checkbox"/>
14	Keyword index	<input type="checkbox"/>	<input type="checkbox"/>

Table 3: Target groups-section matrix

2 Safety

2.1 Residual risks

2.1.1 Risk of fire and explosion

2.1.1.1 Rechargeable battery

The safety electronics may fail if the batteries are damaged or faulty. The residual voltage can cause a short circuit. The battery may self-ignite and explode.

- ▶ Only use and charge the battery and accessories if they are in perfect condition.
- ▶ Never open or repair the battery.
- ▶ Batteries with external damage must be removed from service immediately.
- ▶ If a battery is dropped or struck, remove it from service and keep it under observation for at least 24 hours.

If a charger is connected to the drive system when the drive system reports a critical error, the battery may be damaged permanently and may catch fire.

- ▶ Connect charger to error-free drive system only.

The battery is only protected from spray water. Penetration by water can cause a short circuit. The battery may self-ignite and explode.

- ▶ Never immerse battery in water.
- ▶ Take battery out of service if you suspect water has penetrated it.

Temperatures over 60 °C can also cause liquid to leak from the battery and the battery will become damaged. The battery may self-ignite and explode.

- ▶ Protect the battery against heat.
- ▶ Never store next to hot objects.
- ▶ Never expose battery to continuous direct sunlight.
- ▶ Avoid wide temperature fluctuations.

Chargers with excessive voltage damage batteries. This may cause a fire or an explosion.

- ▶ Only use approved batteries to charge.

Metal objects may interconnect the battery's electrical terminals. The battery may self-ignite and explode.

- ▶ Never insert paper clips, screws, coins, keys and other small parts into the battery.
- ▶ Place the battery on clean surfaces only. Prevent charging socket and contacts against contamination from dirt, sand and similar.

Faulty batteries are hazardous goods.

- ▶ Dispose of faulty batteries in the correct manner.
- ▶ Store battery in a dry place until disposal.
- ▶ Never store near flammable substances.

2.1.1.2 Overheated charger

The charger heats up when charging the battery. If the battery is not allowed to cool down sufficiently, it can cause a fire or burns to the hands.

- ▶ Never use charger on a highly flammable surface.
- ▶ Never cover the charger during charging.
- ▶ Never leave battery unattended during charging.

2.1.1.3 Hot components

The brakes and the motor may become very hot during operation. There is a risk of burns or fire in case of contact.

- ▶ Never touch the brakes or the motor immediately after a ride.
- ▶ Never place the pedelec on a flammable surface, such as grass or wood, directly after use.

2.1.2 Electric shock

2.1.2.1 Damage

Damaged chargers, cables and plug connectors increase the risk of electric shock.

- ▶ Check the charger, cable and plug connector before each use. Never use a damaged charger.

2.1.2.2 Water penetration

If water penetrates into the charger, there is a risk of electric shock.

- ▶ Never charge the battery outdoors.

2.1.2.3 Condensation

Condensation may form in the charger and in the battery when the temperature changes from cold to hot, causing a short circuit.

- ▶ Wait until both charger and battery are at room temperature before connecting them.

2.1.3 Risk of a crash

2.1.3.1 Incorrect quick release setting

Excessively high clamping force will damage the quick release and cause it to lose its function. Insufficient clamping force will result in unfavourable transmission of force. This can cause components to break. This will cause a crash with injuries.

- ▶ Never fasten a quick release using a tool (e.g. hammer or pliers).
- ▶ Only use the clamping lever with the specified set clamping force.

2.1.3.2 Incorrect tightening torque

If a screw is fastened too tightly, it may break. If a screw is not fastened enough, it may loosen. This will cause a crash with injuries.

- ▶ Always observe the indicated tightening torque on the screw or in the *operating instructions*.

2.1.3.3 Incorrect component

The wheels are designed exclusively for use with rim brakes or disc brakes. The wheel may break if an incorrect brake is used. This will cause a crash with injuries.

- ▶ Never use the wheel with a different brake.

2.1.4 Risk of amputation

The brake disc in disc brakes is so sharp that it can cause serious injuries to fingers if they are inserted into the brake disc openings.

- ▶ Always keep fingers well away from the rotating brake discs.

2.1.5 Key breaking off

If you leave a key inserted when riding or transporting the pedelec, it may break off or the locking system may open accidentally.

- ▶ Pull the key from the battery lock.

2.1.6 Malfunctions due to Bluetooth®

If you use the on-board computer with Bluetooth® and/or Wi-Fi®, it may cause interference with other devices, other equipment, aircraft, and medical devices, such as pacemakers and hearing aids.

Likewise, harm to people and animals in the immediate vicinity cannot be completely excluded.

- ▶ Never use the pedelec with Bluetooth® when in close proximity to medical devices, filling stations, chemical plants, areas at risk of explosion and in blasting zones.
- ▶ Never use pedelec with Bluetooth® in aircraft.
- ▶ Avoid operating for longer periods in close proximity to the body.

2.1.7 Data privacy information

When the pedelec is connected to the BOSCH diagnosis tool 3, data is transferred to BOSCH eBike Systems (Robert Bosch GmbH) on the use of the Bosch drive unit, including its energy consumption and temperature, to help improve the product.

You will find more information on the Bosch eBike website:

www.bosch-ebike.com.

2.2 Toxic substances

2.2.1 Brake fluid

Brake fluid may leak out after an accident or due to material fatigue. Brake fluid can be fatal if swallowed or inhaled.

- ▶ Never dismantle the brake system.
- ▶ Avoid contact with skin.
- ▶ Do not inhale vapours.

2.2.2 Defective battery

Liquids and vapours may leak from damaged or faulty batteries. Excessively high temperatures may also cause liquids and vapours to leak from the battery. Such liquids and vapours can irritate the airways and cause burns.

- ▶ Never dismantle the battery.
- ▶ Avoid contact with skin.
- ▶ Do not inhale vapours.

2.3 Requirements for the rider

The rider must have adequate physical, motor and mental abilities to ride on public roads. A minimum age of 14 years is recommended.

2.4 Vulnerable groups

Keep batteries and the charger away from children and people with reduced physical, sensory or mental capacities or lacking in experience and knowledge.

If minors use the pedelec, a legal guardian must should provide them with comprehensive instructions.

2.5 Personal protective equipment

- ▶ Wear a suitable helmet. The helmet must have a reflective strip or a light in a clearly visible colour.
- ▶ Wear sturdy shoes.
- ▶ Wear clothing which is as bright or retroreflective as possible. Fluorescent materials are also suitable. High-visibility jackets and straps on your upper body ensure even greater safety. Never wear a skirt. Always wear trousers which reach down to your ankles instead.

2.6 Safety guards

Three safety guards on the pedelec protect riders against heat or moving parts:

- Chain or belt guards prevent clothing from being pulled into the drive train.
 - The motor cover on the motor casing protects against heat.
 - Mudguards protect against dirt and water splashing up from the road.
- ▶ Never remove the guards.
 - ▶ Check the guards on a regular basis.
 - ▶ Take pedelec out of service if a guard is damaged or missing. Contact your specialist dealer.

2.7 Safety markings and safety instructions

The pedelec and battery nameplates contain these safety markings and safety instructions:



Symbol	Explanation
	General warning
	Adhere to the instructions for use

Table 4: Meaning of safety markings











Symbol	Explanation
	Read the instructions
	Separate collection of electrical and electronic devices
	Separate collection of ordinary and rechargeable batteries
	Must not be thrown into fire (burning prohibited)
	It is forbidden to open any batteries
	Device of protection class II
	Only suitable for use indoors
	Fuse (device fuse)
	EU conformity
	Recyclable material
	Protect from temperatures above 50 °C and direct sunlight

Table 5: Safety instructions

2.8 What to do in an emergency

2.8.1 Dangerous situation in road traffic

- ▶ If you encounter any hazards or dangers in road traffic, apply the brake on the pedelec until it comes to a halt. The brake acts as an emergency stop system in such cases.

2.8.2 Leaked brake fluid

- ▶ Remove those affected from the danger area to fresh air.
- ▶ Never leave those affected unattended.
- ▶ Immediately remove any clothing items contaminated with brake fluid.
- ▶ Never inhale vapours. Ensure sufficient ventilation.
- ▶ Wear gloves and safety gloves as protective equipment.
- ▶ Keep unprotected persons away.
- ▶ Take care with leaked brake fluid as it poses a slip hazard.
- ▶ Keep leaked brake fluid away from naked flames, hot surfaces and sources of ignition.
- ▶ Avoid contact with skin and eyes.

After inhalation

- ▶ Take in fresh air. Immediately consult a doctor in case of any discomfort.

After skin contact

- ▶ Wash affected skin with soap and water and rinse well. Remove contaminated clothing. Consult doctor in the event of pain or discomfort.

After contact with eyes

- ▶ Rinse eyes under flowing water for at least ten minutes with the lids open; also rinse under lids. Immediately consult a doctor in case of any pain or discomfort.

After swallowing

- ▶ Rinse out mouth with water. Never induce vomiting. Risk of aspiration.
- ▶ If a person is lying on their back and vomiting, place them in the recovery position. Seek medical advice immediately.

Environmental protection measures

- ▶ Never allow brake fluid to flow into the sewage system, water courses or groundwater.
- ▶ Notify the relevant authorities if fluid penetrates the ground, water courses or the sewage system.
- ▶ Dispose of leaked brake fluid in an environmentally responsible way in accordance with statutory regulations (see Section 10.1).
- ▶ The brake system must be repaired immediately if brake fluid leaks out. Contact your specialist dealer.

2.8.3 Battery vapours emitted

Vapours may be emitted if the battery is damaged or used improperly. The vapours may cause respiratory tract irritation.

- ▶ Get into fresh air.
- ▶ Consult doctor in the event of pain or discomfort.

After contact with eyes

- ▶ Carefully rinse eyes with plenty of water for at least 15 minutes. Protect unaffected eye. Seek medical advice immediately.

After skin contact

- ▶ Remove any solid particles immediately.
- ▶ Rinse the affected area with plenty of water for at least 15 minutes. Then dab the affected skin gently. Do not rub dry.
- ▶ Remove contaminated clothing immediately.
- ▶ Immediately consult a doctor if there is any redness, pain or discomfort.

2.8.4 Battery fire

The safety electronics may fail if the battery is damaged or faulty. The residual voltage can cause a short circuit. The battery may self-ignite and explode.

- 1 Keep your distance if the battery becomes deformed or starts to emit smoke.
 - 2 If charging, remove the plug connector from the socket.
 - 3 Contact the fire service immediately.
- ▶ Use Class fire extinguishers to put out the fire.
 - ▶ Never extinguish damaged batteries with water or allow them to come into contact with water.

Inhaling vapours can cause intoxication.

- ▶ Stand on the side of the fire where the wind is blowing from.
- ▶ Use breathing apparatus if possible.

3 Description

3.1 Proper use

All check lists and instructions for actions in these operating instructions must be met. Approved accessories can be installed by specialist staff.

Use the pedelec when it is in perfect, proper working order only. National requirements may apply to the pedelec which the standard equipment may not meet. Different regulations apply across the country to the riding light, reflectors and other components when riding on public roads. The general laws and the regulations for the prevention of accidents and environmental protection in the respective country of use must be adhered to.

The rechargeable batteries are designed to supply power to the pedelec motor only. Never use the batteries for other purposes.

A compatible smartphone with the eBike Flow app, available from the Apple App Store or the Google Play Store, is required to use the on-board computer to its full extent.

Each pedelec is assigned a pedelec type, which determines its proper use, function and area of use.







City and trekking bicycle	Cycle for children and young adults	Mountain bike	Racing bicycle	Cargo bike	Folding bicycle
					
<p>City and trekking bicycles are designed for comfortable, daily use and are suitable for riding on public roads.</p>	<p>Cycles for children and young adults are suitable for riding on public roads.</p> <p>Legal guardians must read the operating instructions before putting the bike into use. Tell children and young people what the operating instructions contain in a way appropriate to their age.</p> <p>Check the size of the pedelec every 3 months for orthopaedic reasons.</p> <p>Check compliance with the maximum permitted total weight (PTW) every 3 months</p>	<p>Mountain bikes are designed for sports use. Its specific design features are tyres with a thick tread, a reinforced frame structure and wide transmission range.</p> <p>Mountain bikes are sports bikes and not a means of transport. In addition to being physically fit, riders need time to adapt to using the pedelec. Appropriate training is required for its use. It is especially important to practice braking and riding around bends.</p> <p>The strain on hands, wrists, arms, shoulders, the neck and back is considerable. Inexperienced riders tend to brake too hard and lose control as a result.</p>	<p>Racing bikes are designed for fast rides on roads and paths with a good, undamaged road surface.</p> <p>Racing bikes are sports bikes and not a means of transport. Racing bikes are characterised by their lightweight structure and a design which is stripped to the minimum parts required for riding.</p> <p>The frame geometry and the layout of the operating elements are designed to allow the bike to be ridden at high speeds. Learning how to ride slowly, apply the brakes and get on and off the bike safely takes practice due to the frame design.</p> <p>The sitting position is athletic. The strain on hands, wrists, arms, shoulders, the neck and back is considerable. The sitting position requires a high level of physical fitness.</p>	<p>Cargo bikes are suitable for transporting loads on public roads on a daily basis.</p> <p>The transportation of loads requires skill and physical fitness in order to balance the additional weight. The very varied loading conditions and weight distributions require special practice and skill when braking and riding in bends.</p> <p>A longer period is required to adaptation to the length, width and turning circle. You need to be cautious when riding a cargo bike. You must pay attention to the traffic on public roads and the condition of the route accordingly.</p>	<p>Folding bicycles are suitable for riding on public roads.</p> <p>Folding bikes can be folded together and thus save space when they are transported, e.g. in cars or on local transport.</p> <p>The folding function of the folding bicycle makes it necessary to use smaller wheels and longer brake cables and Bowden cables. With increased strain, you should therefore expect a reduction in riding stability, braking power, comfort and durability.</p>

Table 6: Proper use for every type of Pedelec

3.1.1 Improper use

Failure to adhere to the proper use poses a risk of personal injury and material damage. It is prohibited to use the pedelec in the following ways:

- when the electrical drive system has been manipulated
- riding with a damaged or incomplete pedelec
- riding over steps
- riding through deep water
- charging with an incorrect charger
- lending the pedelec to untrained riders
- carrying other people
- riding with excessive baggage
- riding with no hands
- riding on ice and snow
- improper servicing
- improper repair
- tough areas of use, such as professional competitions
- stunt riding or acrobatics.

City and trekking bicycles	Child's bicycles/ bicycles for young adults	Mountain bikes	Racing bicycle	Cargo bike	Folding bicycle
					
City and trekking bicycles are not sports bicycles. If used for sports, the rider can expect reduced riding stability and diminished comfort.	Cycles for children and young adults are not toys.	Mountain bikes must be retrofitted with lighting, a bell and other fittings as specified by national laws and regulations before they are used on public roads.	Racing bikes must be retrofitted with lights, a bell and other fittings as specified by national laws and regulations before they are used on public roads.	Cargo bikes are not a touring or sports bicycle.	A folding bicycle is not a touring or sports bicycle.

Table 7: Information on improper use

3.1.2 Permitted total weight (PTW)

The pedelec may only be loaded to its maximum permitted total weight (PTW).

The maximum permitted total weight is

- the weight of the fully assembled pedelec
- plus body weight
- plus baggage

Type no.	Model	PTW [kg]
KB180-xxFD	Quadriga Pro Belt Automatic, Diamant	150
KB180-xxFT	Quadriga Pro Belt Automatic, Trapez	150
KB180-xxFW	Quadriga Pro Belt Automatic, Wave	150
KB181-xxKD	Quadriga Pro CX12, Diamant	150
KB181-xxKT	Quadriga Pro CX12, Trapez	150
KB181-xxKW	Quadriga Pro CX12, Wave	150
KB182-xxKD	Quadriga Town & Country Pro, Diamant	150
KB182-xxKT	Quadriga Town & Country Pro, Trapez	150
KB182-xxKW	Quadriga Town & Country Pro, Wave	150
KB183-xxKD	Quadriga Town & Country COMP, Diamant	145
KB183-xxKT	Quadriga Town & Country COMP, Trapez	145
KB183-xxKW	Quadriga Town & Country COMP, Wave	145
KB184-xxKD	Quadriga Comp CX11, Diamant	145
KB184-xxKT	Quadriga Comp CX11, Trapez	145
KB184-xxKW	Quadriga Comp CX11, Wave	145
KB185-lxxD	Quadriga Comp Belt CX5, Diamant	145
KB185-lxxT	Quadriga Comp Belt CX5, Trapez	145
KB185-lxxW	Quadriga Comp Belt CX5, Wave	145

Table 8: Type number, model and PTW

3.1.3 Environmental requirements

You can be ride the pedelec within a temperature range between -5 °C and +40 °C. The electric drive system is limited in its performance outside this temperature range.

Operating temperature	-5... +40 °C
-----------------------	--------------

During winter use, especially at temperatures below 0 °C, we recommend that you don't insert a battery charged and stored at room temperature into the pedelec until just before setting off. We recommend using thermal protection sleeves when riding longer distances at low temperatures.

Temperatures under -10 °C and over +60 °C must be avoided as a general rule. Never put the battery in a car in summer or store it in direct sunlight.

You must also keep within the following temperature ranges:

Transportation temperature	+10... +40 °C
Storage temperature	+10... +40 °C
Work environment temperature	+15... +25 °C
Charging temperature	+10... +40 °C

The nameplate contains symbols for the pedelec's area of use.

- Check what tracks and roads you may ride on before setting off for the first time.











City and trekking bicycle	Cycle for children and young adults	Mountain bike	Racing bicycle	Cargo bike	Folding bicycle	City and trekking bicycle
						
 1	Suitable for tarmacked and paved roads.	Suitable for tarmacked and paved roads.		Suitable for tarmacked and paved roads.	Suitable for tarmacked and paved roads.	Suitable for tarmacked and paved roads.
 2	Suitable for tarmacked roads, cycle paths and firm gravel paths and roads, and longer sections with moderate slopes and jumps up to 15 cm.	Suitable for tarmacked roads, cycle paths and firm gravel paths and roads, and longer sections with moderate slopes and jumps up to 15 cm.	Suitable for tarmacked roads, cycle paths and firm gravel paths and roads, and longer sections with moderate slopes and jumps up to 15 cm.	Suitable for tarmacked roads, cycle paths and firm gravel paths and roads, and longer sections with moderate slopes and jumps up to 15 cm.		
 3		Suitable for tarmacked roads, cycle paths and easy to demanding off-road riding, sections with moderate slopes and jumps up to 61 cm.	Suitable for tarmacked roads, cycle paths and easy to demanding off-road riding, sections with moderate slopes and jumps up to 61 cm.			
 4			Suitable for tarmacked roads, cycle paths and easy to demanding off-road riding, limited downhill use and jumps up to 122 cm.			

Table 9: Area of use

The pedelec is unsuitable for the following areas of use:











Area of use	City and trekking bicycles	Child's bicycles/ bicycles for young adults	Mountain bikes	Racing bicycle	Cargo bike	Folding bicycle
 1	 Never drive off-road or perform jumps.	 Never drive off-road or perform jumps.		 Never drive off-road or perform jumps.	 Never drive off-road or perform jumps.	 Never drive off-road or perform jumps.
 2	Never drive off-road or perform jumps over 15 cm.	Never drive off-road or perform jumps over 15 cm.	Never drive off-road or perform jumps over 15 cm.	Never drive off-road or perform jumps over 15 cm.		
 3		Never ride downhill or perform jumps over 61 cm.	Never ride downhill or perform jumps over 61 cm.			
 4			Never traverse extremely difficult off-road terrain or perform jumps over 122 cm.			

Table 10: Unsuitable terrain

3.2 Nameplate

The nameplate is situated on the frame.
The precise position of the nameplate is shown

in [Figure 2](#). The nameplate contains thirteen pieces of information.

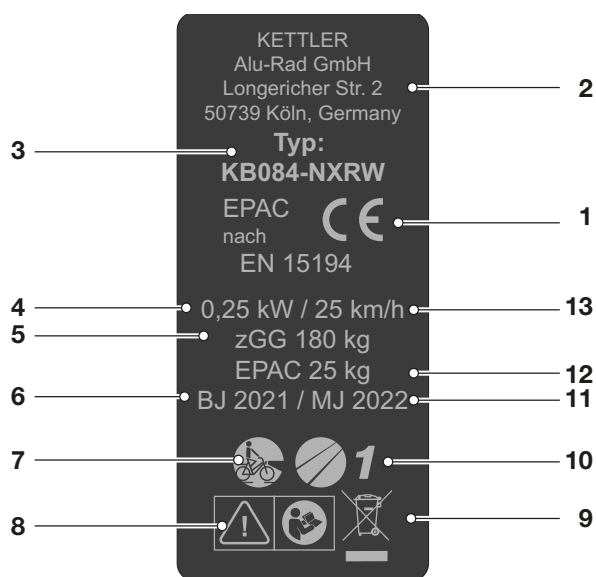

Figure 1: Example KETTLER nameplate

No.	Designation	Description	More information
1	CE marking	The manufacturer uses the CE marking to declare that the pedelec complies with applicable requirements.	
2	Manufacturer's contact details	You can contact the manufacturer at the address indicated.	Section 1.1
3	Type number	All pedelec models have an eight-digit type number, which is used to specify the design model year, the type of pedelec and the version.	Section 1.5
4	Maximum continuous power	The maximum continuous power rating is the maximum possible power for the electric motor output shaft over 30 minutes.	
5	Maximum permitted total weight	The maximum permitted total weight is the weight of the fully assembled pedelec with the rider plus baggage.	
6	Year of manufacture	The year of manufacture is the year in which the pedelec was manufactured. The production period is between June 2021 and June 2022.	
7	Pedelec type	Each pedelec is assigned a Pedelec type, which determines its proper use, function and area of use.	Section 3.2
8	Safety markings	Safety markings warn of hazards.	Section 2.6
9	Disposal instructions	These instructions must be followed when disposing of the pedelec.	Section 10
10	Area of use	The pedelec may only be ridden in authorised locations.	Section 3.6
11	Model year	The model year refers to the first production year that the series-manufactured pedelec was produced in the version concerned. The year of manufacture is different to the model year in some cases.	
12	Weight of the ready-to-ride pedelec	The weight of the ready-to-ride pedelec is specified as a weight of 25 kg or above and refers to its weight at the time of purchase. Extra accessories need to be added to the weight.	Section 4.1
13	Shut-off speed	The speed that the pedelec reaches at the moment when the current has dropped to zero or to the no-load current value.	

Table 11: Explanation of information on the nameplate

3.3 Components

3.3.1 Overview



Figure 2: Pedelec viewed from the right,

1	Front wheel	11	Saddle	21	Frame number
2	Front wheel hub	12	Pannier rack	22	Motor under motor cover
3	Fork	13	Rear wheel mudguard	23	Pedal
4	Front wheel mudguard	14	Rear light and reflector	24	Battery and type number
5	Front light	15	Kickstand	25	Front wheel brake
6	Steering headset	16	Rear wheel		
7	Handlebars	17	Gear shift and rear wheel hub		
8	Stem	18	Rear wheel brake		
9	Frame	19	Chain guard		
10	Seat post	20	Chain		

3.3.2 Chassis

The chassis comprises two components:

- Frame and
- steering system.

3.3.2.1 Frame

The frame absorbs all forces which act on the pedelec from body weight, pedalling and the ground. The frame also acts as a carrier for most components.

The frame geometry determines the pedelec's ride performance.

3.3.2.2 Steering system

The steering system components are:

- Steering headset
- Stem
- Handlebars
- Fork.

3.3.2.3 Steering headset

The steering headset (also known as a bike headset or simply a headset) is the fork bearing system in the frame. A distinction is made between two different types:

- Conventional steering headsets for fork steerers with thread and
- Steering headsets for threadless fork steerers, what are known as headsets.

3.3.2.4 Stem

The stem is the connecting component between the handlebars and the fork steerer tube. The stem is used to adjust the handlebars to the rider. The stem is used to adjust the handlebar height and the gap between the handlebars and saddle (see Section 6.5.6).

Quickly adjustable stems

Quickly adjustable stems are an extension to the fork steerer. You can change the height and angle of quickly adjustable stems without any tools. Up to 3 settings can be adjusted, depending on the model:

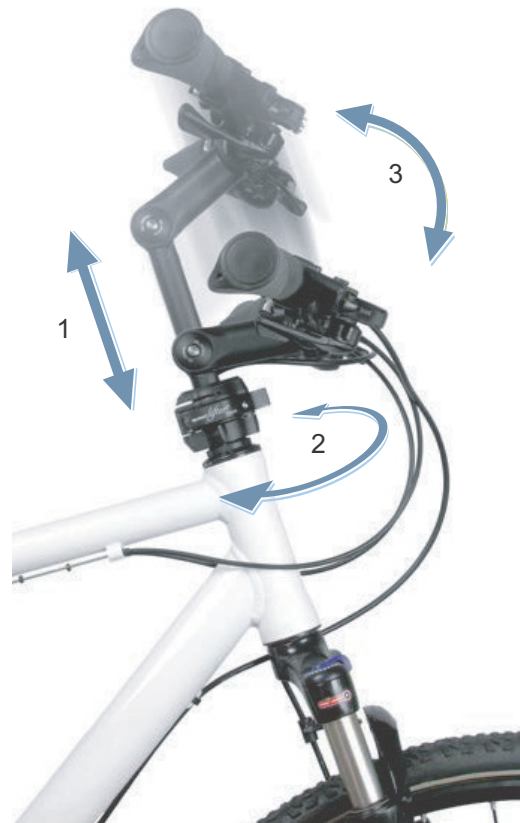

Figure 3: Example – BY.SCHULZ Speedlifter Twist Pro SDS

- 1 Height adjustment
- 2 Twist function
- 3 Stem angle adjustment.

Adjusting the height and stem angle increase ride comfort as different sitting positions can be adopted on longer rides. The twist function saves space when parking.

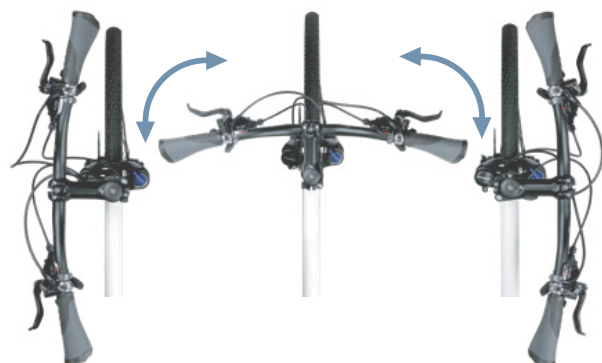

Figure 4: Twist function, using BY.SCHULZ as an example

3.3.2.5 Handlebars

The pedelec is steered using the handlebars. The handlebars are used to support the upper body and is the mount for most controls and displays (see Section 3.4.1).

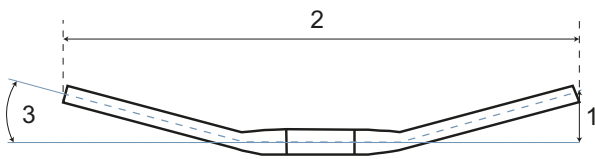

Figure 5: Handlebar dimensions

The main structural dimensions of handlebars are:

- 1 Rise (height)
- 2 Width
- 3 Backsweep

3.3.2.6 Fork

The stem and handlebars are attached to the top end of the fork steerer. The axle is fastened to the fork ends. The wheel is fastened to the axle.

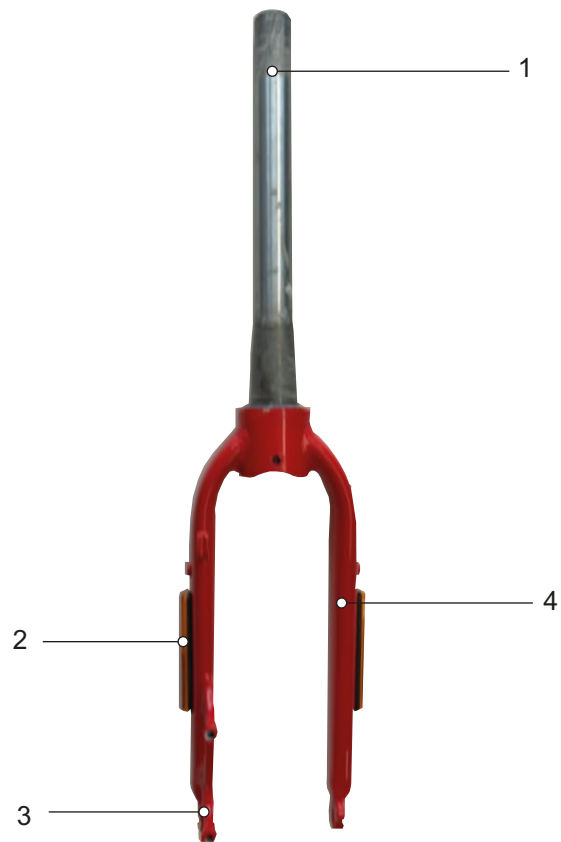

Figure 6: Overview of fork

- 1 Fork steerer
- 2 Side reflectors (optional)
- 3 Fork end
- 4 Fork leg

3.3.3 Suspension

Both forks and suspension forks are fitted in this model series.

3.3.3.1 Rigid fork

Rigid forks do not feature suspension. They transfer the used muscle and motor power to the road to optimum effect. Pedelecs with rigid forks consume less energy on steep roads and have a greater range than pedelecs with suspension.

3.3.3.2 Suspension fork

A fork deflects when a steel spring, air suspension, or both suspension types act on it.

Unlike rigid forks, suspension forks improve contact with the ground and thus enhance comfort using two functions: suspension and damping. The suspension in a pedelec prevents an impact, such as one caused by a stone lying in the pedelec's path, from being channelled directly into the body via the fork. The impact is absorbed by the suspension system instead. This causes the suspension fork to compress.

After compressing, the suspension fork returns to its original position. If the bike has a damper, the damper will slow this movement down. It thus prevents the suspension system from springing back in an uncontrolled manner and the fork from oscillating up and down. Dampers which dampen compressive deflection movements, i.e. a compression load, are called compression dampers or compression dashpots.

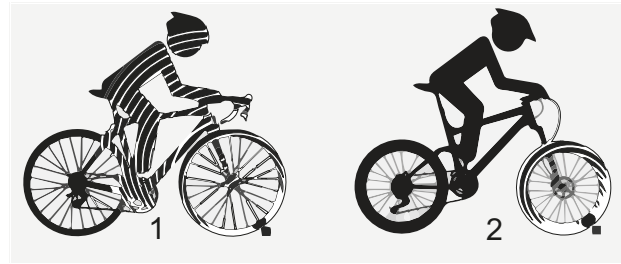

Figure 7: Without suspension (1) and with suspension (2)

Dampers which dampen rebound deflection movements, i.e. a rebound load, are called rebound dampers or dashpots.

The compression can be disabled in any suspension fork. A suspension fork will then behave like a rigid fork.

The stem and the handlebars are fastened to the fork steerer. The wheel is fastened to the axle.

Negative deflection (sag)

The negative deflection (sag) is the percentage of total deflection that is compressed by body weight, including equipment (such as a backpack), the seating position and frame geometry. Sag is not caused by riding. The pedelec rebounds at a controlled speed if it is

optimally adjusted. The wheel stays in contact with the ground when passing over bumps (blue line). The fork head, handlebars and body follow terrain (green line) when riding over bumps. The suspension motion is predictable and controlled.

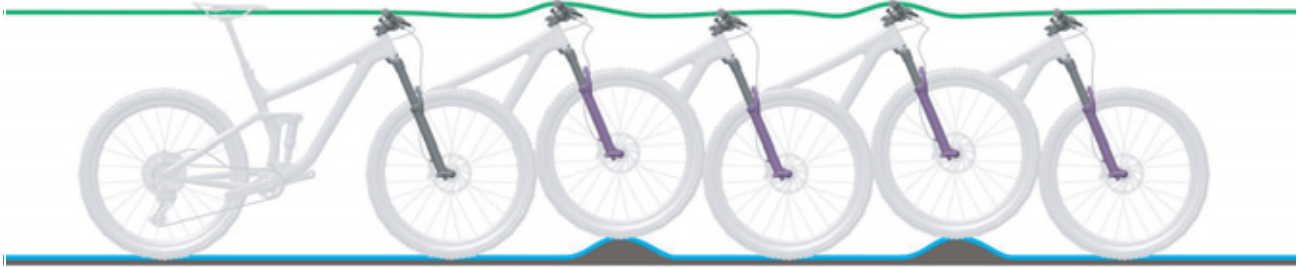

Figure 8: Optimum fork riding performance

When optimally adjusted, the fork counteracts deflection on hilly terrain and stays higher in its

deflection range. This makes it easier to maintain speed when riding over hilly sections of terrain.



Figure 9: Optimum fork riding performance on hilly terrain

When optimally adjusted, the fork deflects quickly and unhindered when the bike hits bumps and absorbs a bump. Traction is retained (blue line).

The fork responds quickly to the bump. The headset and handlebars rise slightly when absorbing a bump (green line).



Figure 10: Optimum fork riding performance over bumps

Rebound damping

Only applies to pedelecs with this equipment

Rebound damping defines the speed at which the suspension rebounds after being loaded.

Rebound damping controls the suspension fork extension and rebound speed, which, in turn, has an impact on traction and control.

Rebound damping can be adjusted to body weight, spring stiffness, deflection, the terrain and the rider's preferences.

If the air pressure or spring stiffness increases, the extension and rebound speeds also increase.

Rebound damping needs to be increased to achieve an optimal setting if the air pressure or spring stiffness are increased.

The damper rebounds at a controlled speed if the fork is optimally adjusted. The wheel stays in contact with the ground when passing over bumps (blue line).

The fork head, handlebars and body follow terrain (green line) when riding over bumps. The suspension motion is predictable and controlled.



Figure 11: Optimum fork riding performance

Suspension fork compression adjustment

Only applies to pedelecs with this equipment

The compression adjuster allows the rider to make quick adjustments to the fork's suspension behaviour to adapt to the changes in terrain. It is intended for adjustments made during the ride.

The compression adjuster controls the compression lifting speed or the rate at which the fork deflects slow impacts. The compression adjuster affects the absorption of bumps and its efficiency when weight shifts or during transitions,

cornering and uniform impacts caused by bumps, and when braking. When optimally adjusted, the fork counteracts deflection, stays higher in its deflection range and helps to maintain speed while riding on hilly parts of terrain. The fork deflects quickly and unhindered when the bike hits a bump and absorbs the bump. Traction is retained (blue line).



Figure 12: Optimum performance on hilly terrain

Steel suspension fork structure

The stem and the handlebars are fastened to the fork steerer. The wheel is fastened to the axle.

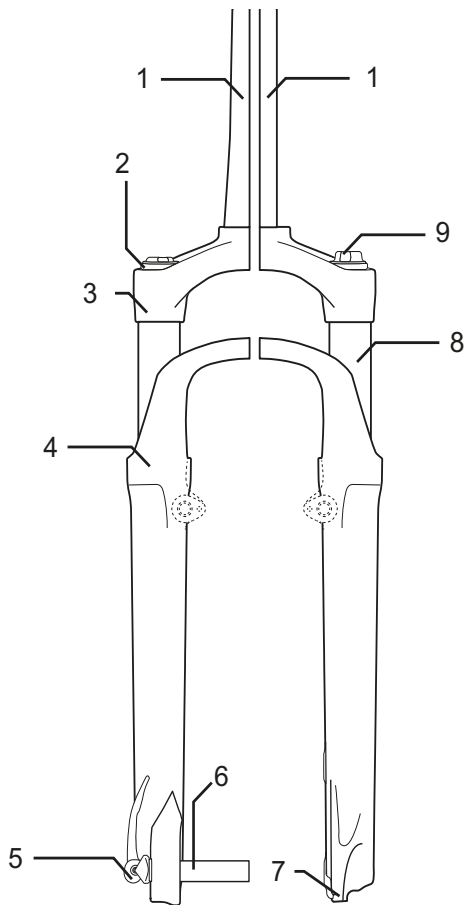

Figure 13: Suntour steel suspension fork as an example

- | | |
|---|--------------------|
| 1 | Fork steerer |
| 2 | Sag setting wheel |
| 3 | Crown |
| 4 | Dust seal |
| 5 | Q-Loc |
| 6 | Axle |
| 7 | Fork end |
| 8 | Stanchion |
| 9 | Compression damper |

Air suspension fork structure

Depending on the model, the air suspension fork has either

- an air suspension assembly group (orange) and/or
- a compression damper assembly (blue) and/or
- a rebound damper assembly group (red)

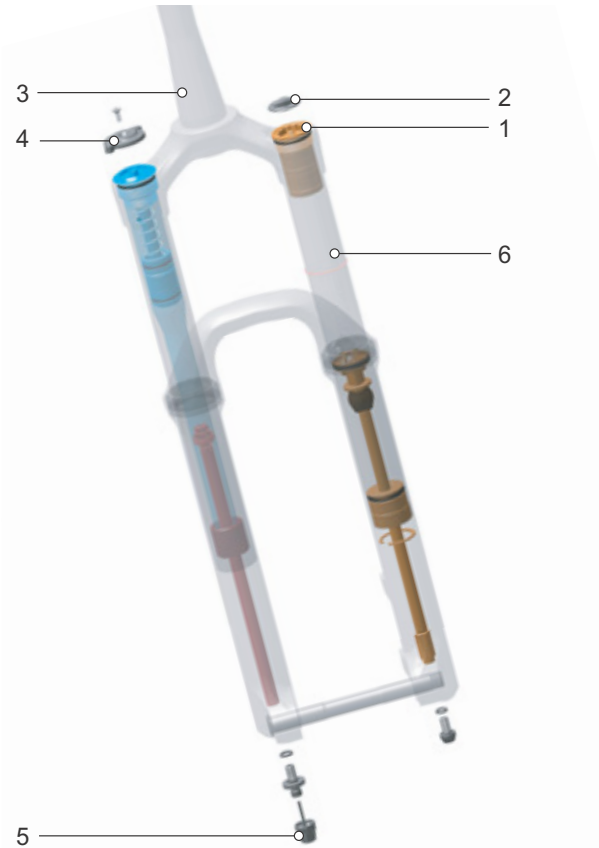

Figure 14: Internal structure of air suspension fork

- | | |
|---|-------------------|
| 1 | Air valve |
| 2 | Air valve cap |
| 3 | Fork steerer |
| 4 | Sag setting wheel |
| 5 | Rebound adjuster |
| 6 | Stanchion |

3.3.4 Wheel

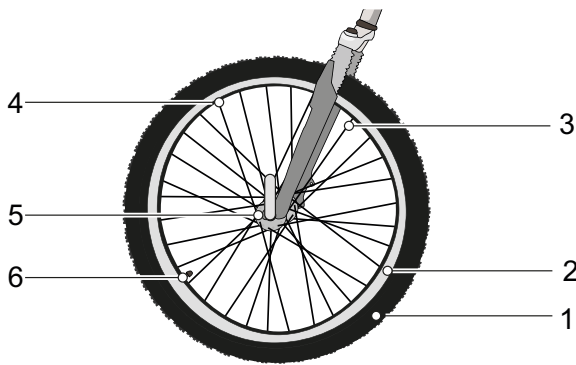

Figure 15: Visible wheel components

- | | |
|---|---------------|
| 1 | Tyres |
| 2 | Rim |
| 3 | Spoke |
| 4 | Spoke nipples |
| 5 | Hub |
| 6 | Valve |

The wheel comprises the *wheel* itself, an inner tube with a valve and a tyre.

3.3.4.1 Tyres

The tyre forms the outer section of the wheel. Tyres differ in their tread, depending on their intended use.

Tread

The tread has little influence on riding characteristics on a smooth road. In this case, the grip between the road and tyre is mainly due to the rolling friction between the rubber and the road surface.

Unlike cars, a pedelec will not aquaplane. The tread contact is much smaller and the contact pressure much higher. Theoretically, aquaplaning will not occur until speeds of 200 km/h are reached.

However, the tread is highly important on terrain. In this case, the tread creates an interlock with the ground. This is the only way possible to transmit the driving, braking and steering forces. The tread can also help improve control on dirty road surfaces.

If a tyre with a deep tread is used on asphalt, this may make an unpleasant noise when the brakes are used. In such a case, the specialist dealer needs to replace the tyre with a new one with a shallow tread.



Figure 16: Example: Information on tyres

Tyre pressure

The permitted pressure range is indicated on the side of the tyre. It is indicated in psi or bars.

The tyre is only able to support the pedelec if there is adequate tyre pressure. The tyre pressure must be adjusted to the rider and then checked on a regular basis.

Tyre size

The tyre size pressure range is indicated on the side of the tyre.

3.3.4.2 Rim

The rim is the metal profile on a wheel which holds the tyre, tube and rim band together. The rim is joined to the hub with spokes.

In rim brakes, the outer surface of the rim is used to brake.

3.3.4.3 Valve

Each wheel has a valve. Air is pumped into the tyre via the valve. There is a valve cap on each valve. The screw-on valve cap keeps out dust and dirt.

The pedelec has either:

- a conventional valve
- a Presta valve or
- a Schrader valve.

Dunlop valve

The Dunlop valve, also known as a conventional valve, is the valve in most widespread use. The valve insert can be replaced easily and air can be let out very quickly.



Figure 17: Dunlop valve

Presta valve

The Presta valve, also known as the French valve (FV) or Sclaverand valve, is the narrowest variant of all valves. The Presta valve requires a smaller hole in the rim, which is why it is especially suitable for the narrow rims on racing bikes. It is about 4 to 5 g lighter than a Dunlop or Schrader valve.



Figure 18: Presta valve

Schrader valve

The Schrader valve can be pumped at filling stations. Older and easy bicycle pumps are unsuitable for filling tyres via a Schrader valve.



Figure 19: Schrader valve

3.3.4.4 Spoke

A spoke is a rod that connects the hub to the rim. The bent end of the spoke which is hooked into the hub is called the spoke head. A thread between 10 mm and 15 mm is attached to the other end of the spoke.

3.3.4.5 Spoke nipples

Spoke nipples are screw elements with an internal thread which fits onto the spoke thread. Fitted spokes are tensioned by tightening the spoke nipples. This straightens the wheel uniformly.

3.3.4.6 Hub

The hub is located in the centre of the wheel. The hub is connected to the rim and tyre with the spokes. An axle runs through the hub, connecting the hub with the fork at the front and with the frame at the rear.

The hub's main task is to transfer the pedelec's force of weight to the tyres. Special hubs on the rear wheel perform additional functions. There is a distinction between five types of hub:

- Hubs without additional features
- Brake hub, see Back-pedal brake
- Gear hub, also known as a hub gear
- Generator hub, see Hub dynamo
- Motor hub.

3.3.5 Braking system

A pedelec's brake system is primarily operated using the brake lever on the handlebars.

- If the left brake handle is pulled, the brake on the front wheel is applied.
- If the right brake handle is pulled, the brake on the rear wheel is applied.

The brakes are used as an emergency stop system and bring the bicycle to a halt quickly and safely in the event of an emergency.

The brake is applied using the brake lever either

- with the brake lever and shift cable (mechanical brake) or
- with the brake lever and hydraulic brake cable (hydraulic brake).

3.3.5.1 Mechanical brake

The brake lever is connected with the brake via a wire inside the shift cable (also known as a Bowden cable).



Figure 20: Bowden cable structure

3.3.5.2 Hydraulic brake

The brake fluid is in a closed hose system. If the brake lever is pulled, the brake fluid transfers pressure to the brake on the wheel.

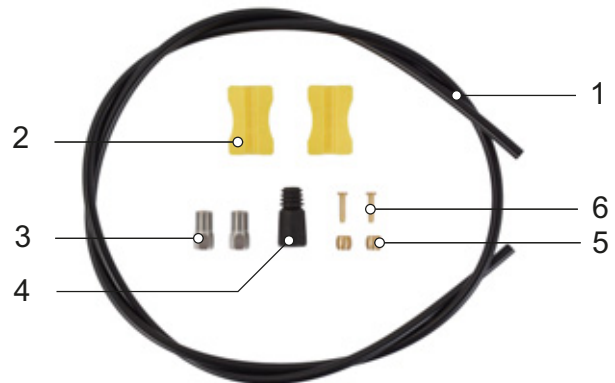

Figure 21: Components in a brake cable

- | | |
|---|-------------|
| 1 | Brake cable |
| 2 | Cable clip |
| 3 | Union nut |
| 4 | Cover cap |
| 5 | Knob |
| 6 | Insert pin |

3.3.5.3 Disc brake

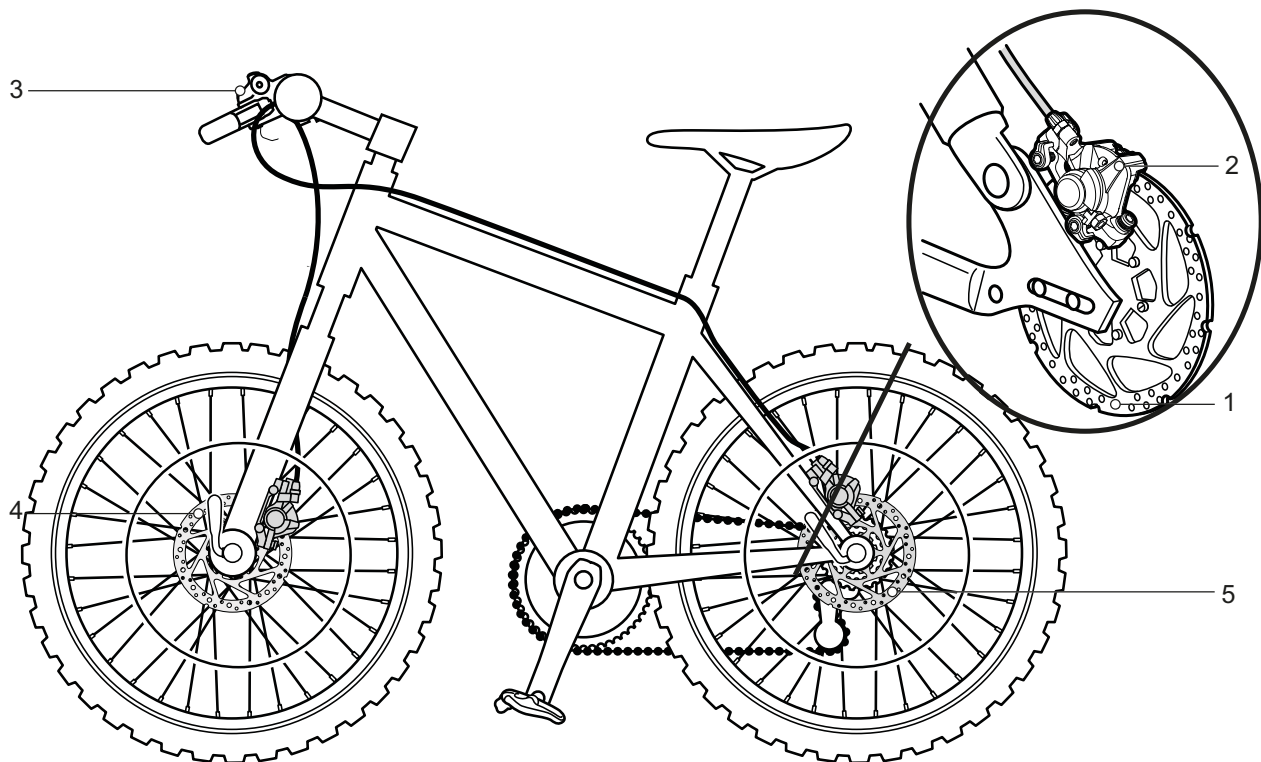

Figure 22: Brake system with disc brake – example

- 1 Brake disc
- 2 Brake calliper with brake linings
- 3 Handlebars with brake lever
- 4 Front wheel brake disc
- 5 Rear wheel brake disc

On a pedelec with a disc brake, the brake disc is screwed permanently to the wheel *hub*.

You increase brake pressure by pulling the *brake lever*. The brake fluid is used to transfer pressure through the brake cables to the cylinders in the brake calliper. The braking force is boosted by a speed reduction and applied to the brake linings. These apply the brake disc mechanically. If the *brake lever* is pushed, the brake linings are pressed against the brake disc and the wheel movement is decelerated until it comes to a stop.

3.3.6 Seat post

Seat posts are not designed to fasten the saddle but also to adjust exactly to the optimum sitting position. The seat post can:

- adjust the seat height in the seat tube
- adjust the saddle horizontally with a clamping mechanism and
- adjust the saddle angle by swivelling the entire saddle clamping mechanism.

Retractable seat posts feature a remote control on the handlebars, which can be used to lower the seat post – at a traffic light, for example – and raise it again.

3.3.6.1 Patent seat post



Figure 23: Example of ergotec patent seat post with either one or two seat clamping screws

Patent seat posts have a rigid link between the saddle and the post. Patent seat posts which are angled more markedly towards the rear are called offset seat posts. Offset seat posts provide a greater distance between the saddle and the handlebars.

In patent saddle posts, the saddle is attached to the head with one or two saddle clamping screws. It is recommended to lubricate the thread in these screws to ensure sufficient tension when tightening the screw.

Patent saddle posts are fastened into the seat tube with either a quick release or a screwable clamp.

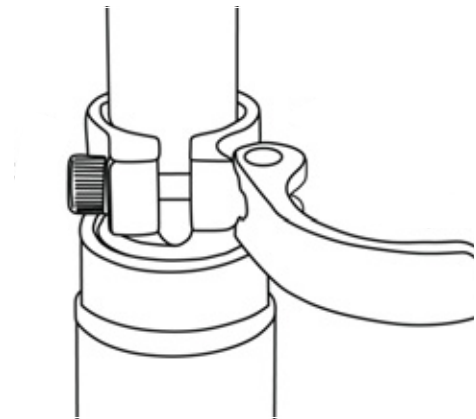

Figure 24: Example of a quick release

3.3.6.2 Suspension seat post

Spring-loaded seat posts can reduce shock after one-time hard impacts, thus improving ride comfort significantly. However, suspension seat posts are not able to compensate for bumps in the road.

If the seat post is the only suspension element, the entire vehicle is a non-suspended mass. This has an unfavourable effect on loaded touring bikes or pedelecs with child trailers.

Suspension seat posts feature small, heavy-duty slide bearings, guides and articulated joints. If they are not lubricated on a regular basis, the sensitive response behaviour diminishes considerably, causing excessive wear.

The pre-tensioning in non-damped suspension seat posts must be adjusted in such a way that the suspension seat post does not deflect with just body weight. This prevents the suspension seat post from deflecting and bobbing intermittently at higher pedalling frequencies or if the rider pedals irregularly.

The spring stiffness can be set lower with damped suspension seat posts, thus making use of the negative deflection.

3.3.7 Mechanical drive system

The pedelec is driven by muscle power, just like a bicycle.

The force which is applied by pedalling in the direction of travel drives the front chain wheel. The chain or belt transmits the force onto the rear chain wheel and then onto the rear wheel.

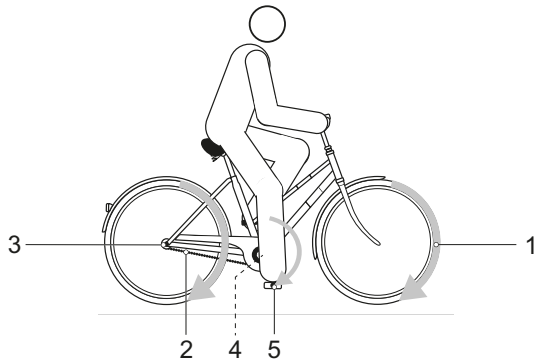

Figure 25: Diagram of mechanical drive system

- | | |
|---|----------------------------------|
| 1 | Direction of travel |
| 2 | Chain or belt |
| 3 | Rear chain wheel or belt pulley |
| 4 | Front chain wheel or belt pulley |
| 5 | Pedal |

The pedelec is equipped with either a chain or belt drive.

3.3.7.1 Chain drive layout



Figure 26: Chain drive with derailleur gears

- | | |
|---|-----------------|
| 1 | Rear derailleur |
| 2 | Chain |

A chain drive is compatible with

- Back-pedal brake,
- Hub gear or
- Derailleur gears

3.3.7.2 Belt drive layout



Figure 27: Belt drive

- | | |
|---|-------------------|
| 1 | Front belt pulley |
| 2 | Rear belt pulley |
| 3 | Belt |

A belt drive is compatible with

- Back-pedal brake and
- Hub gear

A belt drive is not compatible with derailleur gears.

3.3.8 Electric drive system

The pedelec has an electric drive system in addition to a mechanical one.

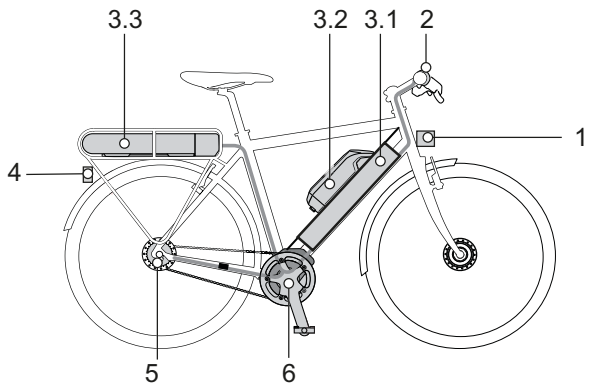

Figure 28: Diagram of an electric drive system with electric components

- | | |
|-----|--|
| 1 | Front lamp |
| 2 | On-board computer |
| 3.1 | Integrated battery and/or |
| 3.2 | Frame battery and/or |
| 3.3 | Pannier rack battery |
| 4 | Rear light |
| 5 | Electric gear shift (alternative) |
| 6 | Motor |
| (7) | A charger which is designed for the battery (not shown). |

3.3.8.1 Motor

As soon as the muscle power required for pedalling passes a certain level, the motor is activated gently and assists the pedalling motion. The motor power always depends on the power used to pedal: Motor assistance is lower when little muscle power is used than when muscle power is used. This happens regardless of the level of assistance.

The motor switches off automatically as soon as the rider no longer pedals, the temperature is outside the permitted range, there is an overload or the shut-off speed of 25 km/h has been reached.

A push assist system can be activated. The speed depends on the selected gear. The motor continues to drive the pedelec as long as the rider presses the push assist button on the handlebars. The speed can be a maximum of 6 km/h in this case. The electric drive system stops when the

push assist button is released. The pedelec does not have a separate emergency shut-off button. In the event of an emergency, the motor can be stopped by removing the on-board computer. The mechanical brakes are used as an emergency stop system and bring the bicycle to a halt quickly and safely in the event of an emergency.

3.3.8.2 Rechargeable battery

BOSCH batteries are lithium ion batteries which are developed and manufactured to the latest technical standards. Each battery cell is protected by a steel cup and encased in a plastic battery housing. Applicable safety regulations are met.

- The battery has an interior electronic protection circuit, which is specifically designed for the charger and the pedelec.
- The battery temperature is monitored at all times.
- The battery is protected against deep discharge, overcharging, overheating and short circuits by Electronic Cell Protection (ECP).

In the event of a hazard, a protective circuit switches the battery off automatically. In the event of a hazard, a protective circuit switches the battery off automatically.

The battery has a high energy content when charged. The code of practice for their safe handling is found in Section 2 Safety and Section 6.9 Rechargeable battery in the operating instructions. If the electric drive system is not used for 10 minutes and no button has been pressed on the on-board computer or the control panel, the electric drive system and the battery are automatically switched off to save energy.

The type and duration of operating conditions have a significant effect on the battery life. Just like any other lithium-ion battery, the battery will age naturally if it is not being used. The battery's service life can be extended if the battery is well maintained and stored at the correct temperature. The charging capacity will decrease with age, even if the battery is maintained properly. If the operating time is severely shortened after charging, this is a sign that battery has reached the end of its useful life.

Battery performance is reduced when the temperature drops since this increases electrical

resistance. You should expect the range to be less than normal at low temperatures in winter. We recommend using thermal protection sleeves when riding longer distances at low temperatures.

Each battery has its own lock.

3.3.8.3 Charger

Each pedelec is supplied with a charger. The following BOSCH charger may be used:

- the 4 A Charger BPC3400.

Observe the operating instructions in the Section 11.4 Documents.

3.3.8.4 Lighting

When the riding light is activated, the front light and rear light are switched on together at the same time.

3.3.8.5 Integrated battery

The following battery can be built into the pedelec:



PowerTube 750

Figure 29: Overview of integrated battery

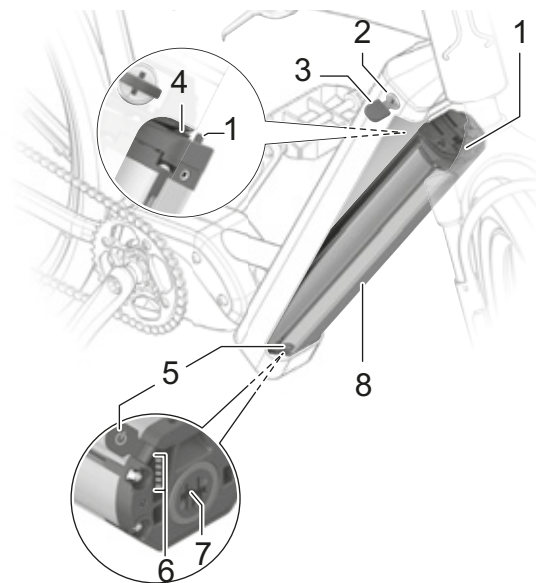

Figure 30: Detail of PowerTube 750

- | | |
|---|-----------------------------------|
| 1 | Securing hook |
| 2 | Battery lock |
| 3 | Battery key |
| 4 | Retainer guard |
| 5 | On-off button (battery) |
| 6 | Battery level indicator (battery) |
| 7 | Socket for charger plug |
| 8 | Battery housing |

3.3.9 On-board computer

The control panel on the handlebars is the on-board computer. It controls the system and all messages on the display screen using seven buttons.



Figure 31: BOSCH LED Remote control panel

The eBike Flow app can be accessed via Bluetooth®.

The control panel has an internal lithium ion battery. The pedelec battery powers the control panel. If a sufficiently charged battery is inserted into the pedelec and the drive system switched on, the internal battery is charged.

3.3.9.1 Display



Figure 32: BOSCH Kiox300 display

The display shows the main drive system functions and the ride data.

The display switches off automatically if it is removed from its mount.

3.4 Description of controls and screens

3.4.1 Handlebars



Figure 33: Detailed view of handlebars with BOSCH Kiox300, example

1, 6	Handle	7	LED Remote control panel
2	Rear wheel hand brake (behind handlebars)	8	Air valve cap
3	Bell	9	Sag setting wheel
4	Kiox300 display	10	Shifter
5	Front wheel hand brake (behind handlebars)		

3.4.2 Control panel

The control panel on the handlebars is the on-board computer. It controls the system and all indicators on the display screen using six buttons.

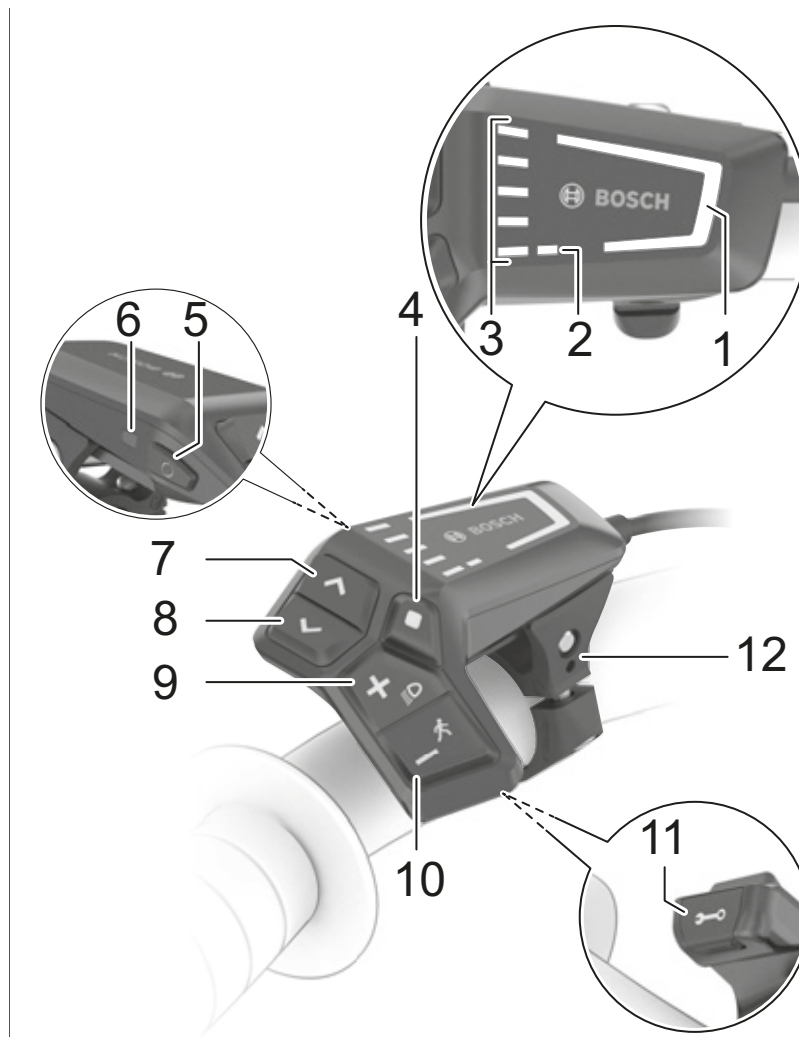

Figure 34: Overview of BOSCH LED Remote control panel

	Symbol	Designation
1		Selected level of assistance indicator
2		ABS indicator (optional)
3		Battery level indicator (control panel)
4	■	Select button
5	⏻	On-Off button (control panel)
6		Ambient light sensor

Table 12: Overview of control panel

	Symbol	Designation
7	>	Increase brightness button/ forward button
8	<	Decrease brightness button/ back button
9	+	Plus button/ light button
10	-	Minus button/ push assist button
11		Diagnosis connection (for maintenance purposes only)
12		Mount

Table 12: Overview of control panel

1. Selected level of assistance indicator

The higher the selected level of assistance, the more the drive system assists with pedalling.

eMTB mode is available for Performance Line CX drives. In eMTB mode, the assistance factor and the torque are dynamically adjusted depending on the pedalling force applied to the pedals.

Level of assistance	Colour	Use
OFF	No	When the drive system is switched on, the motor assistance is switched off. The pedelec can be used like a normal bicycle by simply pedalling.
ECO	Green	Limited assistance with maximum efficiency for maximum range
TOUR	blue	Constant assistance, for long-range tours
eMTB/SPORT	Purple	Powerful assistance, for sporty start-up, optimal assistance on all types of terrain
TURBO	Red	Maximum assistance up to high pedalling frequencies, for sport riding

Table 13: Overview of levels of assistance

2. ABS indicator (optional)

The ABS indicator lights up on pedelecs with an ABS system when they start up.

The ABS will switch off if the pedelec reaches a speed of 6 km/h.

If there is a fault, the ABS indicator lights up together with the indicator of the selected level of assistance, which will flash orange.

Press the Select button to acknowledge the fault and the flashing indicator for the selected level of assistance will go out. The ABS indicator remains lit to indicate that the ABS system is not in operation.

3. Battery level indicator (control panel)

The battery level indicator (control panel) shows the battery charge level. You can also see the battery charge level on the LEDs on the battery itself.

Each blue bar on the indicator signals 20% capacity and each white bar 10% capacity. The top bar indicates maximum capacity. The two lower indicators will change colour if the capacity is low:

Bars	Capacity
5 × blue	100...91%
4 × blue + 1 × white	90...81%
4 × blue	80...71%
3 × blue + 1 × white	70...61%
3 × blue	60...51%
2 × blue + 1 × white	50...41%
2 × blue	40...31%
2 × orange	30...21%
1 × orange	20...11%
1 × red	10%...reserve
1 x red, flashing	Reserve...empty

Table 14: Battery level indicator (control panel)

The uppermost bar will flash if the battery is charging.

3.4.2.1 System message

The control panel indicates whether a critical or less critical error has arisen in the drive system.

The error messages generated by the drive system can be read in the eBike Flow app and by the specialist dealer.

The rider can use a link in the eBike Flow app to display all information on errors and assistance on eliminating errors.

You will find more information and a table containing all system messages in Section 6.2.

3.4.2.2 Creating a user account

The rider needs to register on a PC or their smartphone and create a user account to use all the drive system's functions.

The user account can be used to change settings, analyse routes and ride data and activate premium functions among other things.

3.4.2.3 Software updates

Software updates are automatically transferred to the on-board computer in the background of the Bosch eBike Flow smartphone app as soon as the app is connected to the on-board computer.

Once an update has been completely transferred, this is displayed three times when the on-board computer is restarted.

Alternatively, the user can check whether an update is pending under SETTINGS <My eBike> <Components>.

3.4.2.4 Activity tracking

User recognition is required on a PC or smartphone to record activities.

The rider needs to agree to location data being saved on the portal or the app to record activities. Only then will all activities be displayed on the portal or app.

Your location will only be logged if the on-board computer is connected to the eBike Connect app.

Activities will be displayed after synchronisation in the app and on the portal.

3.4.2.5 Lock function

When the lock function is used, the on-board computer acts in a similar way to a key for the drive system. Once the lock function is switched on, the e-bike drive unit assistance is deactivated by removing the on-board computer. The rider can continue to use the mechanical drive system.

It can then only be activated using the on-board computer belonging to the pedelec. The lock function is linked to the eBike Connect app user account.

The lock function does not consist of theft detection; it is more a supplement to a mechanical lock. The lock function does not provide mechanical blocking of the pedelec or similar. It only deactivates assistance from the drive unit.

If third parties are to have temporary or permanent access to the pedelec, the lock function must be deactivated in the eBike Connect app.

When activating and deactivating the lock function, the drive system emits audible lock signals. The audible feedback signal is activated by default. The feedback signal can be deactivated under SETTINGS <My eBike>.

3.4.3 Display

The display is controlled using the control panel.



Figure 35: BOSCH Kiox300 display

The following pages are on the display screen:

- START SCREEN – see section [3.4.8.1](#)
- STATUS SCREEN – see section [3.4.8.3](#)
- SETTINGS, see Section [3.4.8.5](#)

3.4.3.1 START SCREEN

If no other page was selected before the last time display was switched off, the START SCREEN is displayed.

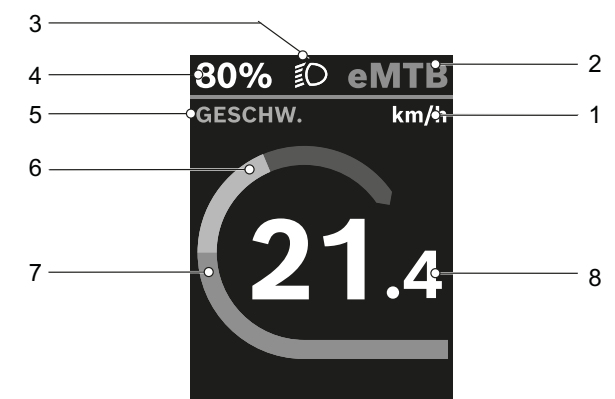

Figure 36: Overview of start screen

- 1 Unit of speed
- 2 Selected level of assistance indicator
- 3 Riding light symbol
- 4 Battery level indicator (display screen)
- 5 Title screen
- 6 Own power indicator
- 7 Motor power indicator
- 8 Speed indicator

Indicators 2 to 4 make up the status bar and are displayed on every page.

1. Unit of speed

The unit of speed is displayed either in km/h or mph.

2. Selected level of assistance indicator

The higher the selected level of assistance, the more the drive system assists with pedalling.

eMTB mode is available for Performance Line CX drives. In eMTB mode, the assistance factor and the torque are dynamically adjusted depending on the pedalling force applied to the pedals.

Level of assistance	Use
OFF	When the drive system is switched on, the motor assistance is switched off. The pedelec can be used like a normal bicycle by simply pedalling.
ECO	Limited assistance with maximum efficiency for maximum range
TOUR	Constant assistance, for long-range tours
eMTB/SPORT	Powerful assistance, for sporty start-up, optimal assistance on all types of terrain
TURBO	Maximum assistance up to high pedalling frequencies, for sport riding

Table 15: Overview of levels of assistance

3. Riding light symbol

 The riding light symbol is shown when the riding light is on.

4. Battery level indicator (display screen)

If the on-board computer is removed from its mount, the last battery level message is saved. The battery level indicator (display screen) can be viewed on the STATUS SCREEN and in the status bar.

5. Title screen

The title screen indicates the page name and the displayed function.

6. Own power indicator

The power that is currently being applied to the pedals is displayed as a semi-circle.

7. Motor power indicator

The motor power used is displayed as a bar. The maximum motor power depends on the selected level of assistance

8. Speed indicator

The speed is displayed either in km/h or mph.

3.4.3.2 Status screen



- 1 Clock indicator
- 2 Selected level of assistance indicator
- 3 Riding light symbol
- 4 Battery level indicator (display screen)
- 5 Connections indicator
- 6 Symbol showing connection to smartphone
- 7 Settings

3.4.3.3 Settings

All system and service-relevant values can be read and changed in the settings. The settings menu structure is customised and may change when components or services are added.

Menu	Submenu
My eBike	→ <Range reset>
	→ <Auto trip reset [Current value]>
	→ <Wheel circumf.>
	→ <Components>
System	→ <Language>
	→ <Units>
	→ <Time>
	→ <Time format>
	→ <Brightness>
	→ <Settings reset>
Information	→ <Contact>
	→ <Certificates>°

Table 16: Basic structure of Kiox300 menu and sub-menu

3.4.4 Battery level indicator (battery)

Each battery has its own level indicator:

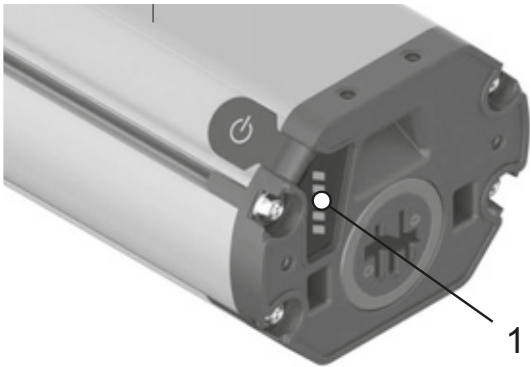

Figure 37: Position of battery level indicator (1)

The five green LEDs on the battery level indicator battery show the charge level when the battery is switched on.

Each LED represents about 20% battery capacity. All five LEDs will light up when the battery is fully charged. If the battery level falls below 5%, all the LEDs on the operating status and battery level indicator will go out.

3.4.5 Gear shift

3.4.5.1 SHIMANO SW-E7000 derailleur gears

Only applies to vehicles with this equipment

The gear shift unit is on the left of the handlebars.
The gear shift unit features 2 buttons.

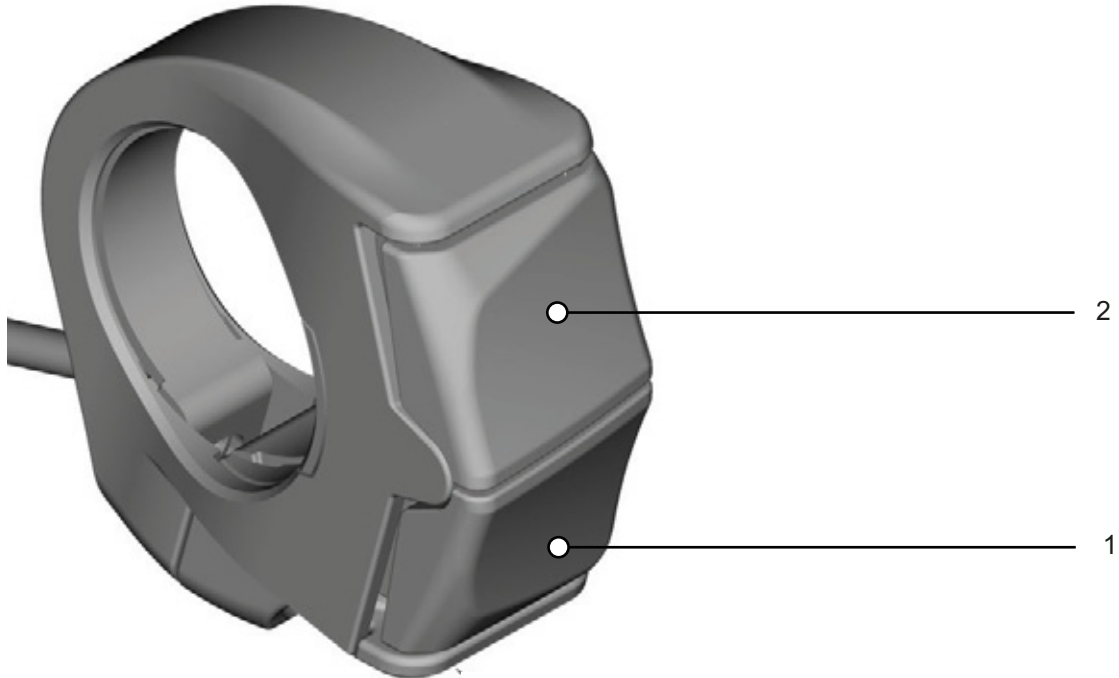

Figure 38: SHIMANOSW-E7000 gear shift

- 1 Up button (gear shift)
- 2 Down button (gear shift)

3.4.6 Fork lock

Only applies to vehicles with this equipment

The suspension in suspension forks is set using fork locks. The fork locks are either directly on the suspension fork or can be controlled using the remote control on the handlebars.

3.4.6.1 SR Suntour

The following (compression adjusters) may be featured on the suspension fork:

Model	RL	RL-R	LO	LO-R	HLO
	Lockout with remote control	Lockout with remote control + rebound adjustment	Lockout on the fork	Rebound adjustment + lockout on the fork	Hydraulic lockout
					
Axon		x		x	
CR			x		x
M3010					
MOBIE25		x		x	
NCX	x		x		
NEX	x		x		x
NVX	x				x
XCE					
XCM	x		x	x	
XCR	x	x	x	x	
XCT					x

Table 17: Fork lock by suspension fork

3.4.7 Hand brake

There is a hand brake on the left and right of the handlebars.

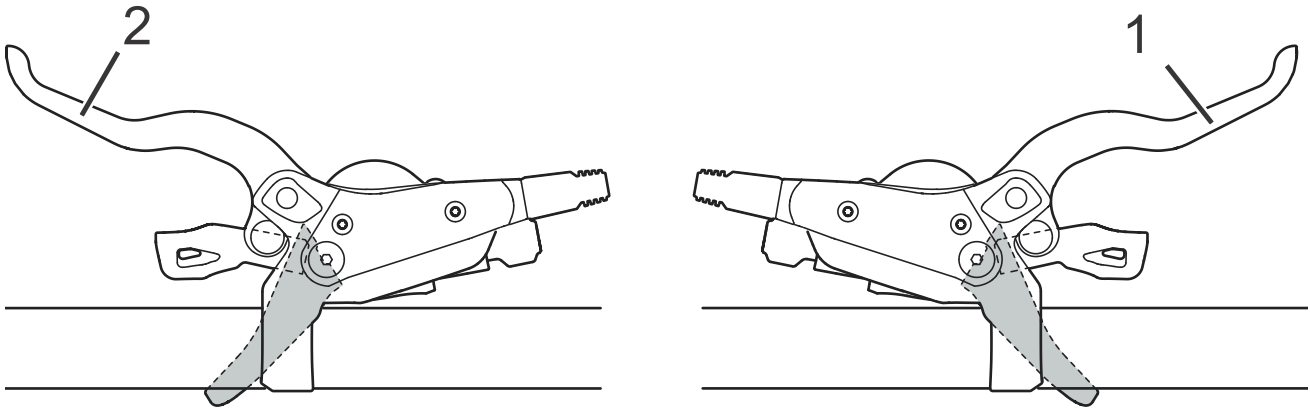

Figure 39: Front wheel (2) and rear (1) brake levers – Shimano brake used as an example

- The left-hand brake controls the front wheel brake.
- The right-hand brake controls the rear wheel brake.

3.5 Technical data

3.5.1 Pedelec

Power output/system	250 W (0.25 kW)
Shut-off speed	25 km/h
Charging temperature	0 °C...+45 °C
Operating temperature	-5 °C...+40 °C
Storage temperature	+10 °C...+50 °C

Table 18: Pedelec technical data

3.5.2 Emissions

The safety requirements as per Electromagnetic Compatibility Directive 2014/30/EU have been met. The pedelec and the charger can be used in residential areas without restriction.

A-weighted emission sound pressure level	< 70 dB(A)
Total vibration level for the hands and arms	< 2.5 m/s ²
Highest effective value of weighted acceleration for the entire body	< 0.5 m/s ²

Table 19: Emissions from the pedelec*

3.5.3 Bicycle lighting

Voltage about	12 V
Maximum output	
Front light	17.4 W
Rear light	0.6 W

Table 20: Bicycle lighting

3.5.4 Display mount

Output voltage	4.75... 5.4 V
Output current, max.	1.5 A
Operating temperature	-5... +40 °C
Storage temperature	+10... +40 °C
Protection class	IP54

Table 21: Technical data for BOSCH Display Mount BDS3210 | BDS3250 | BDS3620 | BDS3630

3.5.5 LED Remote on-board computer

Internal lithium ion battery	3.7 V, 75 mAh
Charging temperature	0 °C...+45 °C
Operating temperature	-5 °C...+40 °C
Storage temperature	+10 °C...+50 °C
Protection class	IP54
Dimensions	74 × 53 × 35
Weight	0.03 kg
Diagnosis interface	
Interface	USB type C®
USB charging cable*	USB type C®
Max. charging current for USB port	600 mA
USB port charge voltage	5 V
BLUETOOTH low energy®	
Frequency	2400...2480 MHz
Transmitting capacity	1 mW

Table 22: Technical data for BOSCH LED Remote on-board computer, BRC3600

*Not included in the standard scope of delivery

3.5.6 BOSCH Kiox300 display

Operating temperature	-5 °C...+40 °C
Storage temperature	+10 °C...+50 °C
Protection class	IP54
Weight about	0.032 kg

Table 23: Technical data for BOSCH KIOX300, BHU3600 display

3.5.7 BOSCH Performance Line CX motor

Maximum continuous power rating	250 W
Max. torque	85 Nm
Nominal voltage	36 V DC
Protection class	IP54
Weight about	3 kg
Operating temperature	-5... +40 °C
Storage temperature	-10... +40 °C

Table 24: Technical data for BOSCH Performance Line CX motor, BDU3740, BDU3741

3.5.8 BOSCH PowerTube 750 battery

Nominal voltage	36 V
Nominal capacity	20.1 Ah
Energy	750 Wh
Weight	4.4 kg
Protection class	IP54
Operating temperature	-5... +40 °C
Storage temperature	+10... +40 °C
Permitted charging temperature range	0... 40 °C

Table 25: Technical data for BOSCH PowerTube 750, BBP3770 horizontal, BBP3771 vertical

3.5.9 Tightening torques

Model	Tightening torque	Screw
On-board computer		
SC-E5003 Attachment screw	0.8 Nm	3 mm hex bit
Shifter		
SHIMANO DEORE SL-M4100 Attachment screw	3 Nm	4 mm hex bit
SHIMANO DEORE SL-M5100 Attachment screw	3 Nm	4 mm hex bit
SHIMANO DEORE SL-M6100 Attachment screw	3 Nm	4 mm hex bit
SHIMANO DEORE XT SL-M8100 Attachment screw	3 Nm	4 mm hex bit
SHIMANO DEORE XT SL-M8130 Attachment screw	3 Nm	4 mm hex bit
SHIMANO SLX SL-M7100 Attachment screw	3 Nm	4 mm hex bit
SHIMANO XTR SL-M9100 Attachment screw	3 Nm	4 mm hex bit
Seat post operating lever		
eightpins Attachment screw	2.5 Nm	4 mm hex bit
Bowden cable fastener	5 Nm	3 mm hex bit
Axle		
Conventional axle nut	35...40 Nm*	
SUNTOUR screw-on axle 12AH2 Axle Securing screw	8...10 Nm 5...6 Nm	6 mm hex bit 5 mm hex bit
SUNTOUR screw-on axle 15AH2 Axle Securing screw	8...10 Nm 5...6 Nm	6 mm hex bit 5 mm hex bit
Handlebars		
Clamping screw, conventional	5...7 Nm*	
Seat post		
by.schulz, G1 M8 seat clamping screw M5 fixing grub screws	20...24 Nm 3 Nm	2.5 mm hex bit
by.schulz, G2 M6 seat clamping screw M5 fixing grub screws	12...14 Nm 3 Nm	2.5 mm hex bit
eightpins NGS2 Seat post axle Slipper clutch Valve cap Postpin axle Rear clamping screw (saddle) M5 attachment screw for outer sleeve	8 Nm 18 Nm 0.5 Nm 8 Nm 8 Nm 0.5 Nm	6 mm hex bit 3 mm hex bit 5 mm hex bit 5 mm hex bit 3 mm hex bit 3 mm hex bit

Table 26: Tightening torques and bits

eightpins H01 Seat post axle Slipper clutch Valve cap Postpin axle Rear clamping screw (saddle) M5 attachment screw for outer sleeve	8 Nm 18 Nm 0.5 Nm 8 Nm 8 Nm 0.5 Nm	6 mm hex bit 3 mm hex bit 5 mm hex bit 5 mm hex bit 3 mm hex bit 3 mm hex bit
LIMOTEC LimoDP Seat post clamping screw Saddle clamping screw	6...7 Nm 7...9 Nm	
SUNTOUR suspension seat post Seat clamping screw M5 fixing grub screws	15...18 Nm 3 Nm	2.5 mm hex bit
Pedals		
Pedal, conventional	33...35 Nm	15 mm spanner

Table 26: Tightening torques and bits

*if there is no other data on the component

4 Transporting and storing

4.1 Weight and dimensions for transportation

Weight and dimensions during transportation

Type no.	Frame	Box dim. [cm]	Weight** [kg]	Shipping weight [kg]
KB180-xxFD	48 cm	#	28	#
	53 cm	#	28	#
	58 cm	#	28	#
KB180-xxFW	43 cm	#	28	#
	48 cm	#	28	#
	53 cm	#	28	#
KB181-xxKD	48 cm	#	28	#
	53 cm	#	28	#
	58 cm	#	28	#
KB181-xxKW	43 cm	#	28	#
	48 cm	#	28	#
	53 cm	#	28	#
KB182-xxKD	46 cm	#	#	#
	51 cm	#	#	#
	56 cm	#	#	#
KB182-xxKW	42 cm	#	#	#
	46 cm	#	#	#
	51 cm	#	#	#
KB183-xxKD	46 cm	#	#	#
	51 cm	#	#	#
	56 cm	#	#	#
KB183-xxKW	42 cm	#	#	#
	46 cm	#	#	#
	51 cm	#	#	#
KB184-xxKD	48 cm	#	28.5	#
	53 cm	#	28.5	#
	58 cm	#	28.5	#
KB184-xxKT	48 cm	#	28.5	#
	53 cm	#	28.5	#

Table 27: Type number, model and pedelec type

Type no.	Frame	Box dim. [cm]	Weight** [kg]	Shipping weight [kg]
KB184-xxKW	43 cm	#	28.5	#
	48 cm	#	28.5	#
	53 cm	#	28.5	#
KB184-xxKT	48 cm	#	28.5	#
KB185-xxFD	48 cm	#	28.5	#
	53 cm	#	28.5	#
	58 cm	#	28.5	#
KB185-xxFW	43 cm	#	28.5	#
	48 cm	#	28.5	#
	53 cm	#	28.5	#

Table 27: Type number, model and pedelec type

** Vehicle weight without battery

Not yet available when the instructions were produced

4.2 Designated handles, lifting points

The box does not have any handles.

4.3 Transportation



Crash caused by unintentional activation

There is a risk of injury if the drive system is activated unintentionally.

- ▶ Remove the battery.

4.3.1 Using the transport securing system

Applicable for pedelec disc brakes only



Oil leak if no transport securing device

The brake securing device prevents the brakes from being applied accidentally during transportation or shipment. This could cause irreparable damage to the brake system or an oil leak, which will harm the environment.

- ▶ Never push the brake lever when the wheel has been dismantled.
 - ▶ Always use the transport securing system when transporting or shipping.
-
- ▶ Insert the **transport securing devices** between the brake linings.
- ⇒ Transport securing device is squeezed between the two linings and prevents undesired sustained braking which can cause brake fluid to leak out.

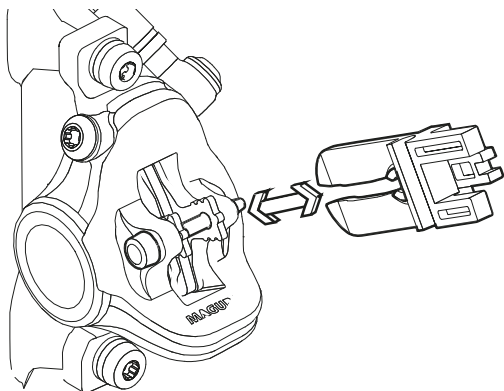

Figure 40: Fastening the transport securing device

4.3.2 Transporting the pedelec

Bicycle rack systems which use the handlebars or frame to hold the pedelec in an upside-down position exert inadmissible forces on its components during transportation. This can cause the supporting parts to break.

- ▶ Never use bicycle rack systems which use the pedelec's handlebars or frame to hold it in an upside-down position. The specialist dealer will give a consultation on correct selection and safe use of a rack system.
- ▶ Take into account the weight of the ready-to-use pedelec when transporting it.
- ▶ Protect the electrical components and connections on the pedelec from the weather conditions with suitable protective covers.
- ▶ Transport the battery in a dry, clean position where it is protected from direct sunlight.

4.3.3 Shipping a pedelec

- ▶ When shipping the pedelec, we recommend that you have the specialist dealer place it in proper packaging.

4.3.4 Transporting the battery

Batteries are subject to hazardous goods regulations. Undamaged batteries may be transported by private persons in road traffic.

Commercial transport requires compliance with regulations concerning packaging, labelling and the transportation of hazardous goods. Open contacts must be covered and the battery securely packaged.

4.3.5 Shipping the battery

The battery is considered a hazardous good and only trained persons may pack and ship a battery. Contact specialist dealer.

4.4 Storing

- ▶ Store the pedelec, on-board computer, battery and charger in a clean, dry place where they are protected from sunlight.
- ▶ Do not store outdoors to ensure a long service life.

Storage temperature	+10... +40 °C
Optimum pedelec storage temperature	+10... +20 °C

Table 28: Storage temperature for batteries and the pedelec

- ✓ Temperatures under -5 °C or over +40 °C must generally be avoided.
- ✓ Storage at about 10 °C to 20 °C is beneficial to a long battery life.
- ✓ Store pedelec, on-board computer, battery and charger separately.
- ✓ Store batteries in rooms with smoke detectors and not near flammable or easily flammable substances and not near sources of heat.

4.4.1 Break in operation

Notice

The battery discharges when not in use. This can cause irreparable damage to the battery.

- ▶ The battery must be recharged every 6 months.

The battery may become damaged if it is connected permanently to the charger.

- ▶ Never connect the battery to the charger permanently.

If the battery is stored for a longer period of time when empty, it can become damaged despite low self-discharge and the storage capacity can be greatly reduced.

- ▶ Store battery with at least 30% charge.

- ▶ Remove the on-board computer from its mount if the pedelec is not going to be used for up to four weeks. Store the on-board computer away safely in a dry environment at room temperature.

- ▶ If the pedelec is removed from service for longer than four weeks, you need to prepare it for a break in operation.

4.4.1.1 Preparing a break in operation

- ✓ Remove the rechargeable battery from the pedelec.
- ✓ Charge battery between 30% and 60% so that 2 to 3 LEDs light up on the battery level indicator.
- ✓ The pedelec needs to be cleaned with a damp cloth and preserved with wax spray. Never wax the friction surfaces of the brake.
- ✓ Before longer periods without use, it is recommended to have the specialist dealer carry out maintenance and basic cleaning and apply preservative agent.

4.4.1.2 Carrying out a break in operation

- 1 Store the pedelec, battery and charger in a dry, clean environment. We recommend storing them in uninhabited rooms with smoke alarms. Dry locations with an ambient temperature between 10 °C and 20 °C are ideal.
- 2 Check the battery level after 6 months. If only one LED on the battery level indicator lights up, recharge the battery to between 30% and 60%.



5 Assembly

WARNING

Risk of eye injury

Problems may arise if components are set incorrectly. They may cause serious injuries to the face.

- ▶ Always wear safety glasses to protect eyes when assembling pedelecs.

CAUTION

Crash and crushing hazard caused by unintentional activation

There is a risk of injury if the drive system is activated unintentionally.

- ▶ Remove the battery.

- ✓ Assemble the pedelec in a clean, dry environment.
- ✓ The *work environment* temperature should be between 15 °C and 25 °C.
- ✓ The fitting stand used must be approved for a maximum weight of least 30 kg.

5.1 Unpacking

The packaging material consists mainly of cardboard and plastic film.

- ▶ Dispose of the packaging in accordance with the regulatory requirements (see Section 10).
- ⇒ Pedelecs are fully assembled in the factory for test purposes and then dismantled for transportation. The pedelec is 95% to 98% pre-assembled.

Scope of delivery

<input type="checkbox"/>	1 pre-assembled pedelec
<input type="checkbox"/>	1 front wheel
<input type="checkbox"/>	2 pedals
<input type="checkbox"/>	2 quick releases (optional)
<input type="checkbox"/>	1 charger
<input type="checkbox"/>	1 set of operating instructions on CD.
<input type="checkbox"/>	1 battery (supplied separately from the pedelec)

5.2 Required tools

The following tools are required to assemble the pedelec:

	Knife
	Ring spanners 8 mm, 9 mm, 10 mm, 13 mm, 14 mm and 15 mm
	Torque wrench Working range 5–40 Nm
	by.Schulz handlebars: TORX® bits: 4 mm, 5 mm and 6 mm If not: Hexagon bits: 4 mm, 5 mm and 6 mm
	Hexagon socket spanner 2 mm, 2.5 mm, 3 mm, 4 mm, 5 mm, 6 mm and 8 mm
	Spline nut socket T25
	Cross-recess screwdriver
	Slotted-head screwdriver

Table 29: Tools required for assembly



5.3 Commissioning

Only trained specialist staff may perform initial commissioning since initial commissioning of the pedelec requires special tools and specialist knowledge.

Experience has shown that a pedelec which has not yet been sold is automatically handed to customers as soon as it appears ready to ride.

- ▶ It makes sense to prepare each pedelec so that it is fully ready for use immediately after being assembled.
- ▶ The assembly report (see Section [11.2](#)) describes all safety-relevant inspections, tests and maintenance tasks.
- ▶ All assembly work must be completed to ensure the pedelec is ready to ride.
- ▶ Complete an assembly report to document quality assurance (see Section 11.1).

5.3.1 Checking the battery

The battery must be checked before it is charged for the first time.

- ▶ Press the **On-Off button (battery)**.
- ⇒ If none of the LEDs on the battery level indicator light up, the battery may be damaged.
- ⇒ The battery may be fully charged if at least one, but not all, of the LEDs on the battery level indicator is lit up.



5.3.1.1 Securing the PowerTube BS3 battery mount

Only applies to pedelecs with this equipment

The BOSCH PowerTube BS3 battery mount must be secured by clamping a clip on its rear.

- 1 Use a TORX® T25 wrench to undo the screws in the battery mount.



Figure 41: Undoing screws on battery mount

- 2 Remove battery mount and turn over.
- 3 Clamp the clip (VLD-I-1222) onto the battery mount on the rear.



Figure 42: Clip (VLD-I-12122)

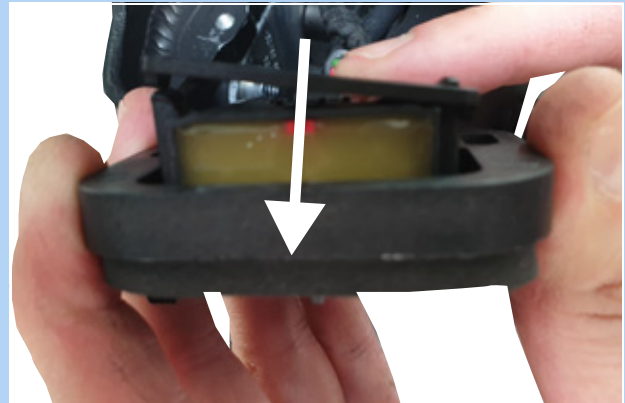

Figure 43: Clamping the clip

- 4 Turn battery mount over and place on the aluminium brace in the frame.
- 5 Use a TORX® T25 wrench to fasten the screws into the battery mount.



5.3.2 Preparing the wheel

There is an arrow on the sides of the tyres with the inscription ROTATION to show the direction of rotation. The inscription says DRIVE on older tyres. The rotation direction arrow indicates the recommended direction of rotation. On road tyres, the direction of rotation is mainly for optical reasons.



Figure 44: Rotation direction arrow

The direction of rotation is much more important on off-road terrain because the tread creates an interlock with the ground. While the rear wheel needs to transmit the drive forces, the front wheel is responsible for transmitting braking and steering forces. Drive and braking forces have different directions of action. This is why some tyres are mounted on the front and rear wheels in opposite directions. On these tyres, there are two rotation direction arrows:

- The FRONT rotation direction arrow indicates the recommended direction of rotation for the front wheel.
- The REAR rotation direction arrow indicates the recommended direction of rotation for the rear wheel.



Figure 45: Rotation direction arrow on MTB tyres

- ▶ The rotation direction arrow must point in the direction of travel when the wheel is placed in the fork.
- ▶ There are also non-directional tyre profiles with no rotation direction arrow.



5.3.3 Installing the wheel in the SUNTOUR fork

Only applies to Suntour forks with this equipment

5.3.3.1 Screw-on axle (12AH2 and 15AH2)

Only applies to Suntour forks with this equipment

✓ Before installing the wheel, ensure that the O-ring is in the right position on the thread piece.

- 1 Insert the front wheel into the fork ends.
- 2 Insert the axle into the hub on the drive side.

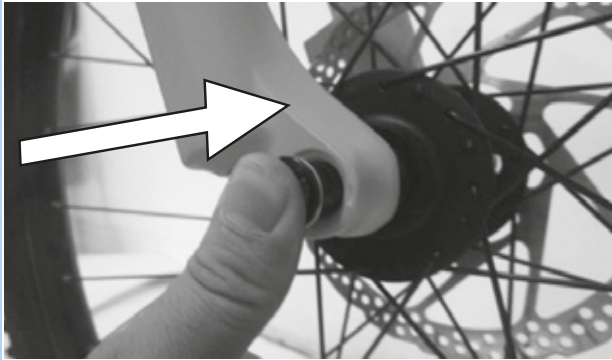

Figure 46: Inserting the axle in the direction of the arrow

- 3 Use a 6 mm hex key to tighten the axle using between 8 and 10 Nm. The axle thread must be visible.



Figure 47: Tighten the axle in the direction of the arrow

- 4 Insert the securing screw on the non-drive side.



Figure 48: Pushing the quick release lever into the axle

- 5 Tighten the securing screw with a 5 mm hex key using between 5 and 6 Nm.



Figure 49: Tightening the securing screw

⇒ The wheel is now fitted.



5.3.3.2 20 mm cross axle

Only applies to Suntour forks with this equipment

CAUTION

Crash caused by loose quick release axle

A faulty or incorrectly installed cross axle may become caught in the brake disc and block the wheel. This will cause a crash.

- ▶ Never fit a defective cross axle.

Crash caused by faulty or incorrectly installed cross axle

The brake disc becomes very hot during operation. Parts of the cross axle may become damaged as a result. The cross axle becomes loose. This will cause a crash with injuries.

- ▶ The cross axle and the brake disc must be opposite one another.

Crash caused by incorrectly set cross axle

Insufficient clamping force will result in unfavourable transmission of force. The suspension fork or the quick release axle may break. This will cause a crash with injuries.

- ▶ Never fasten the cross axle with a tool (e.g. hammer or pliers).

- 1 Insert the cross axle into the hub on the drive side.

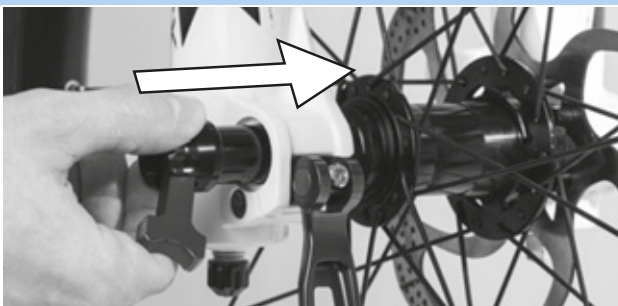

Figure 50: Inserting the cross axle in the direction of the arrow

- 2 Tighten the cross axle with the red handle.

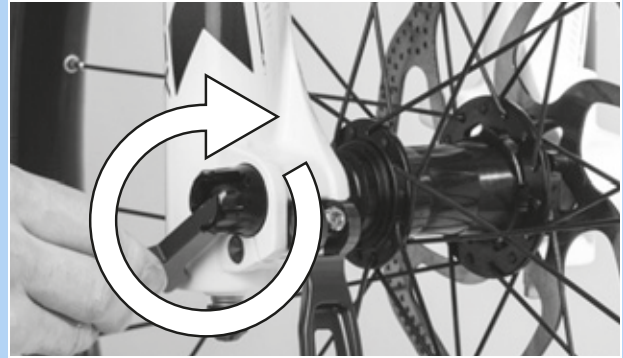

Figure 51: Tighten the axle in the direction of the arrow

- 3 Push red lever into the cross axle.

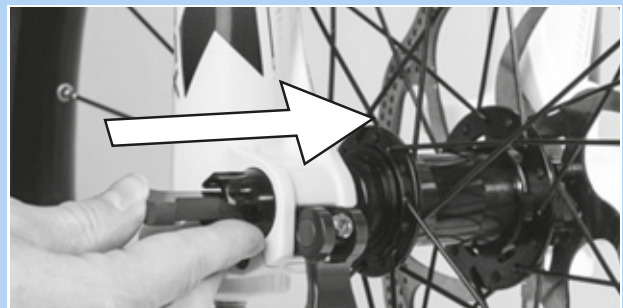

Figure 52: Pushing the red lever in the direction of the arrow

- 4 Closing the quick release lever.



Figure 53: Pressing the quick release lever in the direction of the arrow

⇒ The cross axle is secured.



- 5 Check the position and clamping force of the quick release lever. The quick release lever must be flush with the shock absorber.



Figure 54: Perfect position for the clamping lever

- 6 Use 4 mm hexagon socket spanner to adjust the clamping lever clamping force if required.

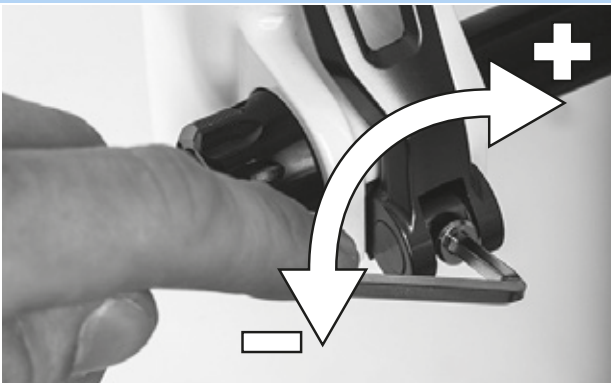

Figure 55: Adjusting the quick release clamping force

- 7 Check the quick release lever position and clamping force.

⇒ The wheel is now fitted.



5.3.3.3 Q-LOC quick release

Only applies to Suntour forks with this equipment

CAUTION

Crash caused by unfastened quick release

A faulty or incorrectly installed quick release may become caught in the brake disc and block the wheel. This will cause a crash.

- ▶ Never fit a defective quick release.

Crash caused by faulty or incorrectly installed quick release

The brake disc becomes very hot during operation. Parts of the quick release may become damaged as a result. The quick release comes loose. This will cause a crash with injuries.

- ▶ The front wheel quick release lever and the brake disc must be situated on opposite sides.

Crash caused by incorrectly set clamping force

Excessively high clamping force will damage the quick release and cause it to lose its function.

Insufficient clamping force will result in unfavourable transmission of force. The suspension fork or the quick release may break. This will cause a crash with injuries.

- ▶ Never fasten a quick release using a tool (e.g. hammer or pliers).
- ▶ Only use the clamping lever with the specified set clamping force.

- ✓ Before installing, ensure that the quick release flange is extended. Open the lever fully.

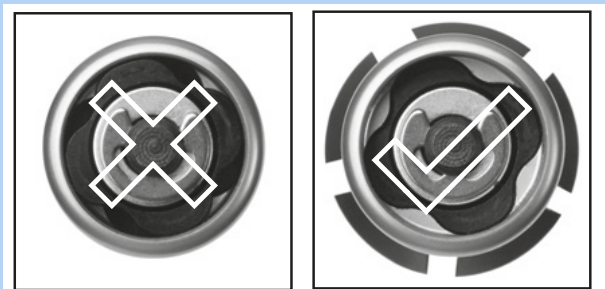

Figure 56: Closed and opened flange

- 1 Push in the quick release until you can hear a click. Make sure that the flange is extended.



Figure 57: Inserting the quick release in the direction of the arrow

- 2 Adjust tensioning with half-open clamping lever until the flange reaches the fork end.

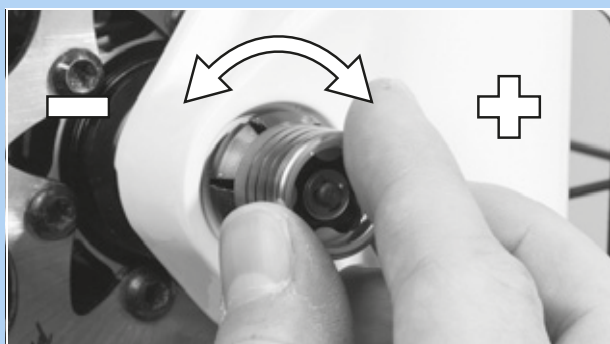

Figure 58: Adjusting the clamping

- 3 Fully close the quick release. Check that it is firmly in place and adjust it on the flange if necessary.



Figure 59: Closing the quick release

⇒ The wheel is now fitted.



5.3.4 Fitting the pedals

The pedals have two different threads to ensure they don't come loose while the rider is pedalling.

- The pedal on the left facing the direction of travel has a left-hand thread and is marked L.
- The pedal on the right facing the direction of travel has a right-hand thread and is marked R.

The mark is either on the top end, the axle or the pedal body.



Figure 60: Example of markings on pedals

- 1 Coat threads in both pedals with waterproof grease.
- 2 Turn the pedal marked L anti-clockwise by hand into the crank arm on the left as seen when facing the direction of travel.



Figure 61: L-pedal in the left-hand crank arm

- 3 Turn the pedal marked R anti-clockwise by hand into the crank arm on the right as seen when facing the direction of travel.



Figure 62: R-pedal in the right-hand crank arm

- 4 Use a 15 mm spanner to fasten the left-hand pedal thread in an anti-clockwise direction and the right-hand pedal in a clockwise direction with a torque between 33 Nm and 35 Nm.



5.3.5 Preparing the LIMOTEC seat post

Only applies to pedelecs with this equipment

- 1 Use the seat height formula to calculate the optimum seat post height for the length of rider's leg:
Seat height (SH) = inner leg length (I) \times 0.9
- 2 Lower the seat post further into the seat tube
- 3 The seat post Bowden cable must be tightened in the frame up to the remote control to the same length as the seat post was lowered.
- 4 Trim the seat post Bowden cable on the handlebars if necessary.



5.3.6 Checking the stem and handlebars

5.3.6.1 Checking the connections

- 1 Stand in front of the pedelec. Clamp the front wheel between your legs. Grasp the handlebar grips.
- 2 Try to twist the handlebars against the direction of the front wheel.
 - ⇒ The stem must not move or twist.
- 3 If the stem can be twisted, check fastening.
 - ⇒ If the stem cannot be fastened, contact your specialist dealer.

5.3.6.2 Checking stem is firmly in position

- 1 Press full body weight on the handlebars.
 - ⇒ The handlebars must not move downwards in the fork.

Stem with clamping lever version I

- 2 If the handlebars should move, increase the lever tension in the clamping lever.
- 3 Turn knurled nut in a clockwise direction with the clamping lever open.
- 4 Close clamping lever and check stem is firmly in position again.
- 5 If the handlebars cannot be fastened, contact your specialist dealer.

Stem with clamping lever version II and stem with screw

- ▶ If the handlebars cannot be fastened, contact your specialist dealer.

5.3.6.3 Checking the headset backlash

- 1 Place the fingers of one hand on the upper headset cup. Pull the front wheel brake with the other hand and try to push the pedelec backwards and forwards.
 - Keep in mind that there may be noticeable backlash due to worn-out bearing bushes or brake lining backlash in suspension forks and disc brakes.
 - ⇒ The headset cup halves must not move towards one another.
- 2 Set bearing clearance as per the stem repair manual as quickly as possible as otherwise the bearing will become damaged. Contact specialist dealer.

5.4 Pedelec sale

- ▶ Complete Pedelec pass on the operating instructions envelope.
- ▶ Note down the manufacturer and the number of the battery key.
- ▶ Adjust the pedelec to the rider; see Section 6.5.
- ▶ Adjust the stand and shifter.
- ▶ Brief operator or rider on all the pedelec's functions (see Section 6.3).

6 Operation

6.1 Risks and hazards

WARNING

Injuries and fatalities caused by blind spots

Other road users, trucks, cars and pedestrians often underestimate the speed of pedelecs. Likewise, other road users frequently do not see pedelecs. This may cause a crash with serious injuries or even death.

- ▶ Wear a helmet. The helmet must have a reflective strip or a light in a clearly visible colour.
- ▶ Clothing should be retroreflective or as light as possible. Fluorescent materials are also suitable. High-visibility jackets and straps on your upper body ensure even greater safety.
- ▶ Always take a defensive approach to riding.
- ▶ Avoid the blind spots of vehicles turning off the road. Reduce speed as a precaution when other road users turn right.

Injuries and death caused by riding incorrectly

A pedelec is not a bicycle. Incorrect riding and underestimated speeds soon result in hazardous situations. This can cause an accident with serious or fatal injuries.

- ▶ Slowly get used to road traffic and speed before riding at speeds over 12 km/h, especially if you have not ridden a bike for some time. Increase the levels of assistance gradually.
- ▶ Practice braking hard on a regular basis.
- ▶ Take and complete a riding safety course.

WARNING

Injuries and death caused by distraction

A lack of concentration while riding increases the risk of an accident. This may cause a crash with serious injuries.

- ▶ Never allow yourself to be distracted by the on-board computer or your mobile phone.
- ▶ Stop the pedelec if you want to make inputs on the on-board computer other than change the level of assistance. Only enter data when stationary.

CAUTION

Crash caused by loose clothing

Shoe laces, scarves and other loose items may become entangled in the spokes on the *wheels* and on the *chain drive*. This may cause a crash with injuries.

- ▶ Wear sturdy footwear and close-fitting clothing.

Crash caused by difficult-to-spot damage

If the pedelec topples over or you have a fall or an accident, there may be difficult-to-spot damage to components such as the brake system, quick releases or frame. This may cause a crash with injuries.

- ▶ Take pedelec out of service. Contact specialist dealer.

**CAUTION****Crash caused by material fatigue**

Intensive use can cause material fatigue. A component may suddenly fail in case of material fatigue. This may cause a crash with injuries.

- ▶ Remove the pedelec from service immediately if there are any signs of material fatigue. Have your specialist dealer inspect the component.
- ▶ Arrange the mandatory maintenance appointments with your specialist dealer on a regular basis. During maintenance, the specialist dealer will inspect the pedelec for any signs of material fatigue on the frame, fork, suspension element mountings (if there are any) and components made of composite materials.

Carbon becomes brittle when exposed to heat radiation such as heating. This can cause the carbon part to break and result in a crash with injuries.

- ▶ Never expose carbon parts on the pedelec to strong sources of heat.

Crash caused by poor road conditions

Loose objects, such as branches and twigs, may become caught in the wheels and cause a crash with injuries.

- ▶ Be aware of the road conditions.
- ▶ Ride slowly and brake in good time.

The *tyres* may slip on wet roads. In wet conditions you must also expect a longer braking distance. The braking sensation differs from the usual sensation. This can cause loss of control or a crash, which may result in injuries.

- ▶ Ride slowly and brake in good time when it is raining.

**CAUTION****Crash caused by soiling**

Heavy soiling can impair pedelec functions, such as braking. This may cause a crash with injuries.

- ▶ Remove coarse soiling before riding.

Notice

Heat or direct sunlight can cause the *tyre pressure* to increase above the permitted maximum pressure. This can destroy the *tyres*.

- ▶ Never park the pedelec in the sun.
- ▶ On hot days, regularly check the *tyre pressure* and adjust it as necessary.

When riding downhill, high speeds may be reached. The pedelec is only designed to exceed a speed of 25 km/h for short intervals. The *tyres* in particular can fail if exposed to a continuous load.

- ▶ Use the brakes to decelerate the pedelec if you reach speeds greater than 25 km/h.

Moisture penetrating at low temperatures may impair individual functions due to the open structural design.

- ▶ Always keep the pedelec dry and free from frost.
- ▶ If the pedelec is used at temperatures below 3 °C, the specialist dealer must perform an inspection beforehand and prepared it for winter use.

Off-road riding subjects the joints in the arms to severe strain. Take a break from riding every 30 to 90 minutes, depending on the road surface and your physical fitness.

6.2 Tips for a greater range

The pedelec's range depends on many influencing factors. A single battery charge may only last fewer than 20 kilometres but much more than 100 is also possible. There are a few tips which will generally help you maximize range.

Suspension elements

- ▶ Only open suspension fork and damper when necessary on terrain or gravel paths. Block suspension fork and damper on tarmacked roads or on hills.

Mileage

The more own physical effort the rider makes, the greater the attainable range is.

- ▶ Shift down 1 to 2 gears to increase the induced power and pedalling frequency.

Pedalling frequency

- ▶ Ride using pedalling frequencies of over 50 revolutions per minute. This optimises the electric drive's efficiency.
- ▶ Avoid pedalling very slowly.

Weight

- ▶ Minimise the total weight of pedelec and baggage.

Stopping and starting

- ▶ Ride long distances at a constant speed.
- ▶ Avoid stopping and starting frequently.

Level of assistance

- ▶ The higher the selected levels of assistance are, the shorter the range is.

Gear shift

- ▶ Use a low gear and a low level of assistance on hills and when setting off.
- ▶ Switch up a gear depending on the speed and terrain.
- ▶ 50-80 crank rotations are optimal.
- ▶ Avoid high stress loads on the crank during a gear change.
- ▶ Switch gear back in good time, e.g. before inclines.

Tyres

- ▶ Always select the right tyres for the surface type. As a general rule, narrower treads move along more easily than heavier ones. Long studs and large grooves usually have an unfavourable effect on energy consumption.
- ▶ When riding on asphalt, it is important to always use the maximum permitted tyre pressure.
- ▶ When riding off-road on gravel tracks or soft woodland or meadow soils, it is important to remember the lower the tyre pressure is, the greater the rolling resistance is and thus the greater electric drive system energy consumption is.

Rechargeable battery

Electrical resistance increases as the temperature drops. Battery performance is reduced. As a result, you should expect the range to be shorter than normal in winter.

- ▶ Use a thermal protection sleeve on the battery in winter.

The range also depends on the battery's age, charge level and state of repair.

- ▶ Maintain the battery and replace older batteries where necessary.

6.3 Error message

6.3.1 On-board computer

The control panel indicates whether a critical or less critical error has arisen in the drive system.

The error messages generated by the drive system can be read in the eBike Flow app and by the specialist dealer.

The rider can use a link in the eBike Flow app to display all information on errors and assistance on eliminating errors.

6.3.1.1 Less critical errors

The indicator for the selected level for assistance will flash orange in the event of less critical errors.

► Press selection button.

⇒ The error is acknowledged and the indicator for the selected level of assistance displays the colour for the configured level of assistance permanently.

You can eliminate errors yourself using the following table when necessary. Contact your specialist dealer if the problem persists.

Code	Description	Method of resolution
0x523005 0x514001 0x514002 0x514003 0x514006	The sensors do not detect the magnetic field properly.	<ul style="list-style-type: none"> ► Check that the magnet wasn't lost while riding. ► If a magnet sensor is used, check that the sensor and magnet have been fitted properly. In doing so, ensure that the cable to the sensor is not damaged. ► If a rim magnet is used, ensure that there are no magnetic field interference near the drive unit.

Table 30: List of on-board computer error messages

6.3.1.2 Critical errors

The indicator for the selected level of assistance and battery level indicator flash red to indicate critical errors.

► Contact specialist dealer.

► Never connect a charger.

6.3.2 Rechargeable battery

The battery is protected against deep discharge, overcharging, overheating and short circuits by Electronic Cell Protection (ECP). In the event of a hazard, a protective circuit switches the battery off automatically. If a fault is detected in the battery, the LEDs flash on the battery level indicator.



Description	Method of resolution
Code: 	
If the battery is outside its charging temperature range, three LEDs will flash on the battery level indicator.	<ol style="list-style-type: none"> 1 Disconnect charger from battery. 2 Leave battery to cool down or warm up. 3 Contact your specialist dealer if the problem persists.
Code: 	
If a fault is detected in the battery, two LEDs flash on the battery level indicator.	<ul style="list-style-type: none"> ► Contact specialist dealer.
Code: 	
No LEDs will light up if there is no power.	<ol style="list-style-type: none"> 1 Check all plug connections. 2 Check contacts on the battery for dirt. Clean the contacts carefully if needed. 3 Contact your specialist dealer if the problem persists.

Table 31: List of battery error messages

6.4 Instruction and customer service

The supplying specialist dealer will provide customer service. Contact details can be found on the pedevec pass for these operating instructions. The specialist dealer will explain all the pedevec functions to the new owner in person, this being when the specialist dealer hands over the pedevec at the latest. These operating instructions are provided with every pedevec, so that the rider can consult them at a later stage.

The supplying specialist dealer will also perform all maintenance, modifications and repairs in the future.

6.5 Adjusting the pedevec



Crash caused by incorrectly adjusted torques

If a screw is fastened too tightly, it may break. If a screw is not fastened enough, it may loosen. This will cause a crash with injuries.

- ▶ Always observe the indicated torques on the screw and in the operating instructions.

Only a correctly adjusted pedevec will guarantee the desired ride comfort and health-promoting activity.

All settings must be re-configured if the body weight or maximum baggage weight changes.

6.5.1 Preparing

The following tools are required to adjust the pedevec:









	Tape measure
	Scales
	Spirit level
	Ring spanners 8 mm, 9 mm, 10 mm, 13 mm, 14 mm and 15 mm
	Torque wrench Working range 5–40 Nm
	Hex key 2 mm, 2.5 mm, 3 mm, 4 mm, 5 mm, 6 mm and 8 mm
	Cross-recess screwdriver
	Slotted-head screwdriver

Table 32: Tools required for assembly

6.5.2 Pedelec adjustment procedure

► Observe the correct order for adjustment.

Sequence	Adjustment	Section	For pedelecs with components only				
			Rhomboid seat post	Ergonomic handles	Suspension fork	Rear frame damper	Headlight
1.1 1.2 1.3 1.4	Saddle <ul style="list-style-type: none"> • Straighten saddle • Adjust saddle height • Adjust saddle position • Adjust saddle tilt 	6.5.4.1 6.5.4.2 6.5.4.4 6.5.4.5					
2	Handlebars	6.5.5					
3	Stem	6.5.6					
4	Handles	6.5.7		x			
5	Tyres	6.5.10					
6.1 6.2 6.3 6.4 6.5	Brake <ul style="list-style-type: none"> • Position of the brake handles • Brake handle tilt angle • Determine grip distance • Adjust the grip distance • Pressure point • Retract the brake linings 	6.5.9.1 6.5.9.2 6.5.9.3 6.5.9.4 6.5.9.8 6.5.9.4					
7	Adjust suspension - Adjust suspension fork sag	6.5.11			x		
	- Adjust the rear frame damper sag (optional)	6.5.12				x	
	- Adjust suspension fork rebound damper	6.5.13			x		
	- Adjust the rear frame damper rebound damper (optional)	6.5.14				x	
	- Adjust the rear frame damper compression damper (optional)	6.5.15				x	
8	Light	6.5.14					x
9	Adjust on-board computer	6.5.15					

6.5.3 Determining the sitting position

The starting point for a comfortable posture is the correct position of the pelvis. If the pelvis is in the wrong position, it can cause different types of pain, e.g. in the shoulder or back.

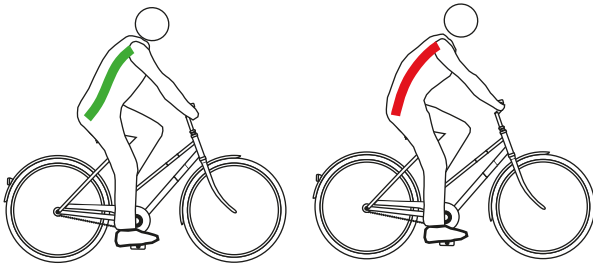

Figure 63: The pelvis is in the right position (green) or incorrect position (red)

The pelvis is in the right position if the spine forms an S-shape and a natural, easy arch.

The pelvis is positioned incorrectly if it tilts slightly backwards. As a result, the spine becomes curved and can no longer deflect to an optimal extent.

A suitable sitting position must be selected beforehand depending on the pedelec type, physical fitness and desired trip distance or speed.

It is especially advisable to check and optimise the sitting position once more before longer rides.

	Position on roadster	Position on city bike	Position on trekking bike	Position on sports bike
				
Angle of upper body (black dashed line)	Upright, almost vertical posture, back at an angle of almost 90°. Handlebars and handles are very close to the upper body.	Slightly inclined upper body, back at an angle of 60°–70°.	Considerably inclined upper body, back at an angle of 30°–60°. Greater distance between handlebars and saddle.	Sharply inclined upper body, back at an angle of 15°–30°. Saddle higher than the handlebars.
Angle between upper arm & upper body (red line)	Extremely acute angle at around 20°. The upper arms are almost parallel to the upper body. The hands are simply placed loosely on the handlebars.	An angle of 75°–80° is optimum. Many people prefer a smaller angle of up to 60° as it requires less effort to support the shoulders, arms and hands.	An angle of 90° is optimum. The muscular support required in the arms, back and shoulder girdle is reduced at 90°.	Above 90°. Shoulders, arms and hands need to provide a great deal of support, the supporting muscles in the back are heavily strained and the load on the bearing surface shifts to the front.
Saddle-handlebar height difference (blue and green line)	>10 The handlebars are positioned far higher than the saddle.	10...5 The handlebars are positioned higher than the saddle.	5...0 Handlebars and saddle are almost at the same height.	<0 The saddle is positioned far higher than the handlebars.
Benefits	The spine is intuitively moved into its natural S-shape. The strain on arms and hands is very slight – no effort required to support.	The upright position provides a good overview in traffic. Force can be applied to the pedals when pedalling without using much energy.	Shoulders, neck and hands provide more of the support effort, thus promoting a dynamic, agile riding style. Impact is reduced on the back, spine and buttocks, which is particularly important on longer rides. The whole body can apply force to the pedals effectively.	Optimum power transmission. Aerodynamic: low air resistance.
Disadvantages	Force is applied relatively inefficiently to the pedals. Weight rests exclusively on the buttocks. The spine slumps after a short time for many people (pelvic straightening).	The arms are often stretched through to the high handlebars – this leads to tense shoulders and painful hands. The spine tends to slump quickly due to the “high position”.	There is greater strain on the hands, neck and shoulders. The muscular system needs to be trained for this higher strain, i.e. riders should practise.	Requires highly trained muscles in back, legs, shoulders, abdomen! Comfortable position only for people who are fit.
Fitness level and use	Low fitness level, occasional cyclists	Medium fitness level, city cyclists	Medium to high fitness level, riding long distances	Speed-oriented, sports cycling
Suitable pedelec types	City bike Folding bike	City bike Cargo bike	Trekking bike	Mountain bike Racing bicycle

Table 33: Overview of sitting positions

6.5.4 Adjusting the saddle

6.5.4.1 Straightening the saddle

- Position saddle in direction of travel. In doing so, align the tip of the saddle with the top tube.

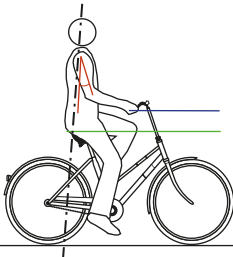
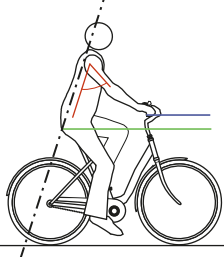
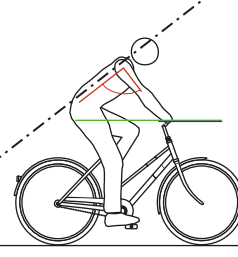
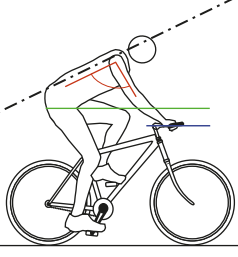
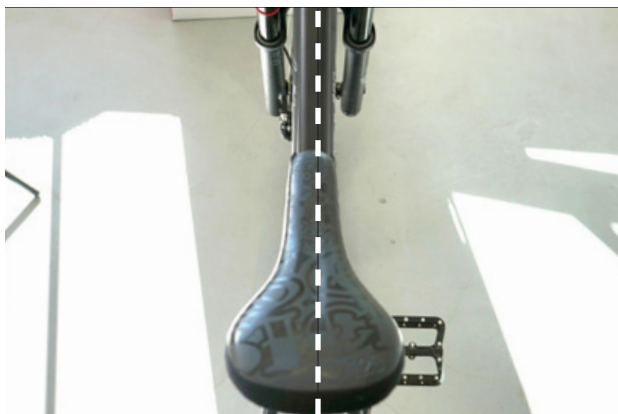

Figure 64: Positioning the saddle in direction of travel

Positioning the saddle with eightpins suspension seat post

Only applies to pedelecs with this equipment

- 1 Position saddle in direction of travel. In doing so, align the tip of the saddle with the top tube.
- 2 Use a torque wrench to tighten the seat post axle with 8 Nm.



Figure 65: Tightening the seat post axle

6.5.4.2 Adjusting the saddle height

- ✓ To adjust the saddle height safely, either:
 - Push the pedelec near to a wall so that the rider can lean on the wall to support themselves or
 - Ask another person to hold the pedelec.
- 1 Use the seat height formula to roughly set the saddle height:
Seat height (SH) = inner leg length (I) \times 0.9
 - 2 Climb onto the bicycle.
 - 3 Place your heel on the pedal and extend your leg, so that the pedal is at the lowest crank rotation point. Your knee should now be fully extended.

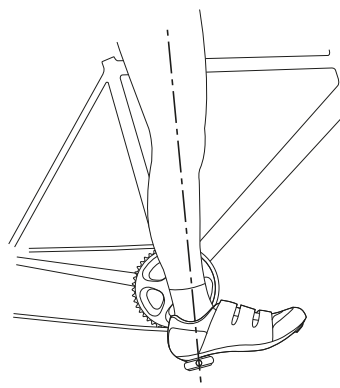

Figure 66: Heel method

- 4 Take a test ride.
 - ⇒ Riders should sit straight on the saddle at an optimal saddle height.
 - If the pelvis moves to the left and right as you pedal, the saddle is too high.
 - If your knees are painful after a few kilometres, the saddle is too low.
 - ⇒ Position the seat post according to needs if necessary. Adjust the seat height with the quick release.

- 5 Open the quick release on the seat post to change the seat height (1). To do so, push the clamping lever away from the seat post (3).

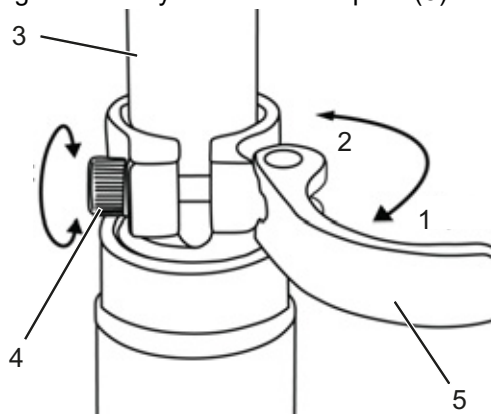

Figure 67: Opening the seat post quick release

- 6 Set the seat post to the required height.



Crash caused by an excessively high seat post setting

A seat post which is set too high will cause the seat post or the frame to break. This will cause a crash with injuries.

- ▶ Do not pull the seat post out of the frame beyond the minimum insertion depth marking.

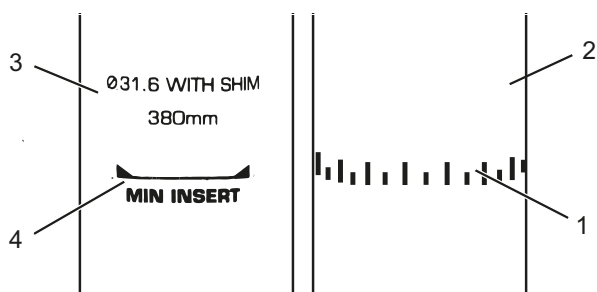

Figure 68: Detailed view of the seat post – examples of the minimum insertion depth marking

- 7 To close it, push the seat post clamping lever as far as it will go into the seat post (2).
- 8 Check the clamping force of the quick releases.

6.5.4.3 Setting the saddle height with the remote control

Use the seat height formula to set the saddle height:

$$\text{Seat height (SH)} = \text{inner leg length (I)} \times 0.9$$

Notice

If you are unable to achieve the required saddle height, the seat post must be lowered further into the seat tube. The seat post Bowden cable must be tightened in the frame up to the remote control to the same length as the seat post was lowered. If this is not possible, contact your specialist dealer.

Lowering the saddle

- 1 Sit on the saddle.
- 2 Press the remote control operating lever.
 - ⇒ The seat post will lower.
- 3 Release the remote control operating lever when you have reached the desired height.

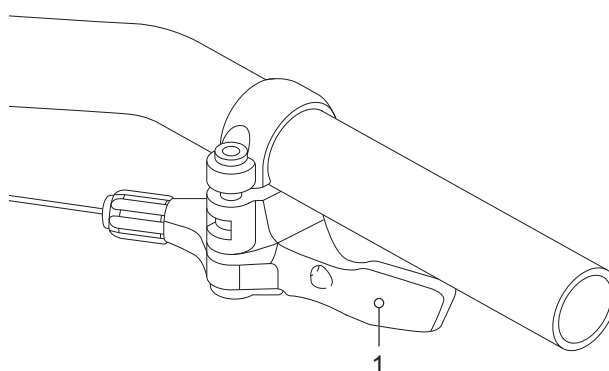

Figure 69: Remote control operating lever (1)

Raising the saddle

- 1 Remove any pressure from the saddle.
- 2 Press the remote control operating lever.
 - ⇒ The seat post will rise.
- 3 Release the remote control operating lever when you have reached the desired height.

6.5.4.4 Adjusting the saddle position

The saddle can be shifted on the saddle frame. The right horizontal position ensures an optimal leverage position for legs. This prevents knee pain and painful incorrect pelvis positions. If you have displaced the saddle more than 10 mm, you need to adjust the saddle height again since both settings affect one another.

- ✓ The saddle setting must only be made when the bicycle is stationary.
- ✓ To set the saddle position, either:
 - Push the pedelec near to a wall so that the rider can lean on the wall to support themselves or
 - Ask another person to hold the pedelec.
- ✓ Move the saddle within its permitted displacement range only (marked on the saddle stay).

1 Climb onto the pedelec.

2 Place the pedals into the vertical position with your feet.

⇒ Riders are adopting the optimal saddle position if the perpendicular line from the kneecap runs through the pedal axle.

- ▶ If the perpendicular line crosses behind the pedal, bring the saddle further forward.
- ▶ If the perpendicular line crosses in front of the pedal, bring the saddle further back.

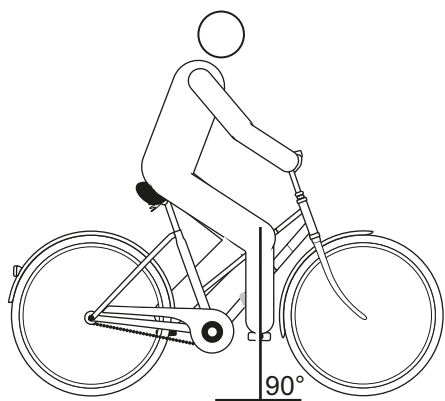

Figure 70: Knee cap perpendicular line

- 3 Unfasten and adjust the designated screw connections, and clamp them with the maximum tightening torque for the saddle clamping screws.

6.5.4.5 Adjusting the saddle tilt

The saddle tilt must be adjusted to the seat height, the saddle and handlebar position, and the saddle shape to ensure an optimum fit. The seating position can be optimised in this way if needed.

The saddle placed in a horizontal position prevents the rider from slipping backwards or forwards. This avoids seat problems. In any other position, the tip of the saddle may press uncomfortably into the crotch area. It is also recommended that the centre of the saddle is exactly straight. This ensures that the rider is seated with their sit bones on the wide rear part of the saddle.

1 Adjust the saddle tilt to horizontal.

2 Position saddle middle so that it is completely straight.

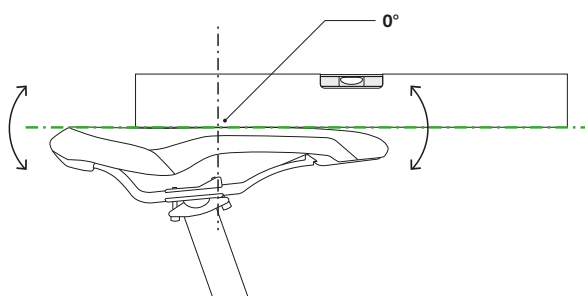

Figure 71: Horizontal saddle tilt with 0° tilt in the centre of the saddle

⇒ Riders sit comfortably on the saddle and do not slip backwards or forwards.

- 3 If the rider tends to slip forwards or sit on the narrow part of the saddle, adjust the seat position (see Section 6.6.2.3) or tilt the saddle very slightly backwards.

6.5.4.6 Checking saddle stability

- ▶ Check saddle stability after adjusting it; see Section 7.5.6.

6.5.5 Handlebars

- ▶ Check handlebar width and hand position.
- ▶ Choose different handlebars if necessary. Contact specialist dealer.

6.5.5.1 Handlebar width

The handlebar width should be as wide as the rider's shoulders as a minimum. This is measured from mid-point to mid-point on the hand contact surfaces.

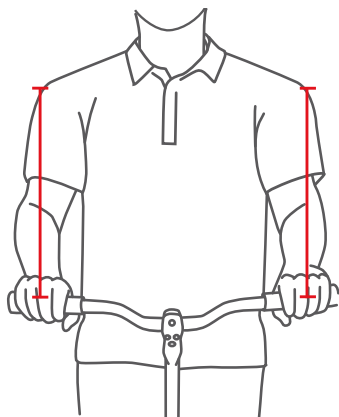

Figure 72: Determining the optimal handlebar width

The wider the handlebars are, the more control they provide, although wide handlebars require greater supporting force. Wider handlebars are particularly useful to ensure a safer ride for loaded touring bikes.

6.5.5.2 Hand position

The hand is in an optimal position on the handlebars when the forearm and hand are in a straight line, i.e. the wrist is not bent. In this way, the nerves are not pinched and do not cause pain.

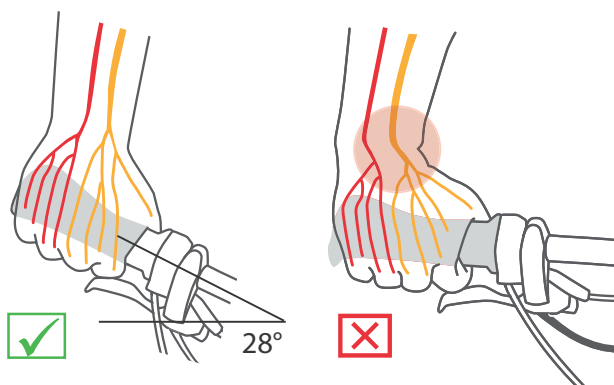

Figure 73: Distribution of nerves with curved and straight handlebars

The narrower the shoulders are, the greater the bend of the handlebars should be (maximum 28°).

Straight handlebars are advisable for sports bikes (e.g. MTB). They support direct steering behaviour, but lead to peaks in pressure and greater muscular strain on the arm and shoulder muscles.

6.5.5.3 Adjusting the handlebars

The handlebars and their position determine the posture that the rider adopts on the pedelec.

- 1 After selecting the seating position (see Section 6.6.2.1), determine the angle of the upper body and of the upper arm.
- 2 Pre-tension the back muscles when adjusting the handlebars. The only way to stabilise the spine and protect it from excessive strain is with the back and abdominal muscles pre-tensioned. Passive muscles are not able to perform this important task.
- 3 Set the required handlebar position by adjusting the stem height and angle (see Section 6.6.6).
- 4 After adjusting the handlebars, check the saddle height and seat position again. The position of the pelvis on the saddle may have changed when the handlebars were adjusted. This can have considerable impact on the position of the hip joint due to the pelvis tilting and may change the usable leg length on the saddle support by up to 3 cm.
- 5 Correct the saddle height and sitting posture if necessary.

6.5.6 Stem

6.5.6.1 Adjusting the handlebar height with quick release

Only applies to pedelecs with this equipment

- 1 Open the stem clamping lever.

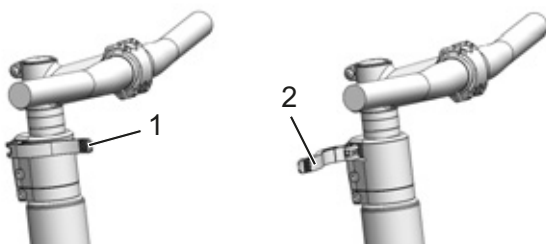

Figure 74: Open (2) and closed (1) stem clamping lever; All Up used as an example

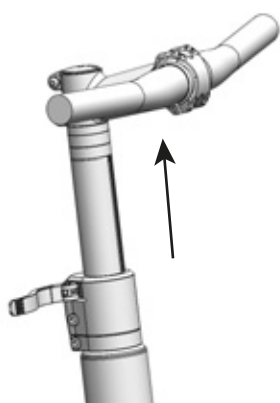

Figure 75: Pulling the locking lever upwards; All Up used as an example

- 2 Pull out the handlebars to the required height. Observe minimum insertion depth.
- 3 Close the stem clamping lever.

Adjusting the quick release clamping force



Crash caused by incorrectly set clamping force

Applying excessive clamping force damages the quick release. Insufficient clamping force will result in unfavourable transmission of force. This can cause components to break. This will cause a crash with injuries.

- ▶ Never fasten a quick release using a tool (e.g. hammer or pliers).

If the *handlebar clamping lever* stops before reaching its end position, unscrew the *knurled nut*.

- ▶ Tighten the *knurled nut* on the seat post if the *seat post clamping lever's* clamping force is not effective enough.
- ▶ Contact your specialist dealer if the clamping force cannot be set.

6.5.6.2 Setting the quill stem

Only applies to pedelecs with this equipment

In the case of a quill stem, the stem and fork steerer form a permanently interconnected component, which is clamped in the fork steerer. The stem and shaft must be replaced together.

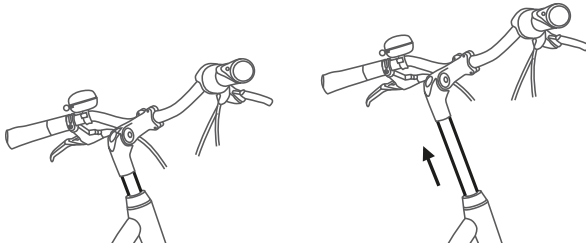

Figure 76: Adjusting the quill stem height

- 1 Undo screw.
- 2 Pull quill stem out.
- 3 Tighten screw.

6.5.6.3 Adjusting the Ahead stem

Only applies to pedelecs with this equipment

In the case of an Ahead stem, the stem is placed directly on the fork steerer, which protrudes over the frame.

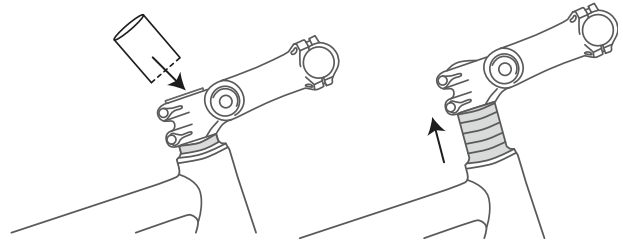

Figure 77: Raising the Ahead stem by fitting spacer rings

The handlebar height is adjusted once during production using spacer rings. The part of the fork steerer protruding is then cut off. The handlebar stem can then no longer be raised.

6.5.6.4 Adjusting the angle-adjustable stem

Only applies to pedelecs with this equipment

Angle-adjustable stems are available in different lengths for quill and Ahead stems.

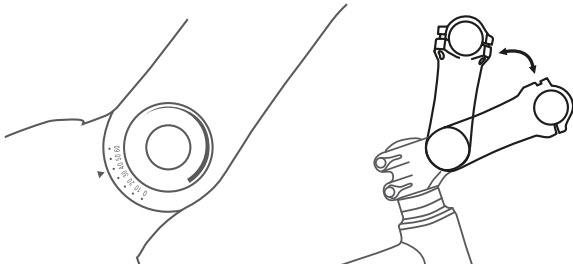

Figure 78: Different versions of angle-adjustable stems

Adjusting the stem angle (c) changes both the distance from the upper body to the handlebars (b) and the handlebar height (a).

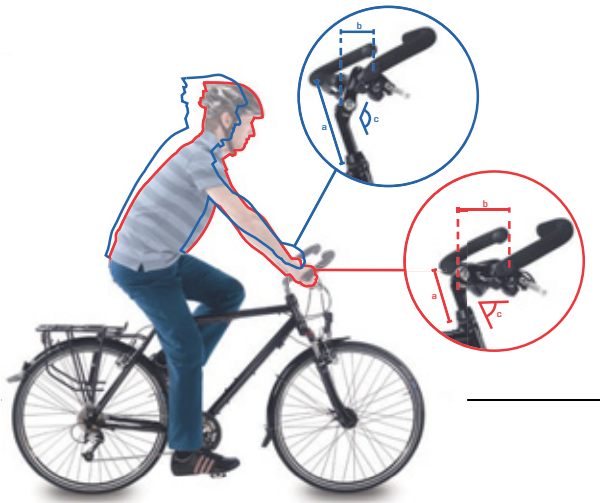

Figure 79: City bike (blue) and trekking bike position (red) by changing the angle

6.5.7 Ergonomic handles

In the case of ergonomically shaped handles, the palm rests on the anatomically shaped handle. A greater contact surface means that the pressure is more evenly distributed. Nerves and vessels are no longer squeezed in the carpal tunnel.

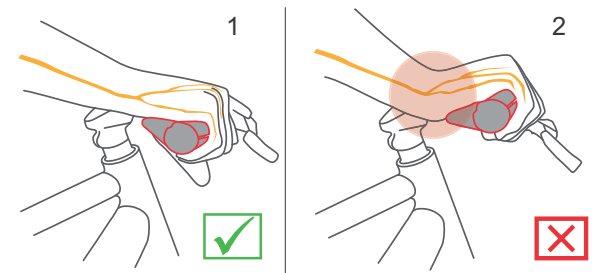

Figure 80: Correct (1) and incorrect (2) position of the handle

- 1 Undo the handle screw.
- 2 Turn handle into the right position.
- 3 Tighten the screw.

6.5.7.1 Checking handlebar stability

► See [Section 7.5.5](#).

6.5.8 Tyres

It is not possible to offer a general recommended tyre pressure for a particular pedelec or tyre. The correct tyre pressure largely depends on the weight load on the tyres, mainly determined by body weight and baggage.

Unlike cars, the weight of the vehicle has only a small impact on the total weight. Moreover, the personal preferences for low rolling resistance or a high degree of suspension comfort vary a great deal. It is important to remember that

- the higher the tyre pressure is, the lower the wear, rolling resistance and the risk of breakdown are.
- The lower the pressure in the tyre is, the greater the comfort and grip that the tyre offers is.

In the case of pedelecs used on the road, the rule is the greater the tyre pressure is, the lower the tyre rolling resistance is. The risk of breakdown is also lower when the pressure is high.

A permanently excessively low tyre pressure often leads to premature wear in the tyre. Cracking in the side wall is a typical consequence of very low tyre pressure. Abrasion is also unnecessarily high.

On the other hand, a tyre can absorb road impacts more effectively at a low pressure.

As a general rule, wide tyres are operated at a lower tyre pressure. They provide the option of exploiting the advantages of the lower tyre pressure without the serious disadvantages it causes with regard to wear, rolling resistance and breakdown protection.

- ✓ Never exceed or go below the minimum and maximum pressure limits indicated on the tyre.

- 1 Pump the tyre to the recommended tyre pressure.

Tyre width	Tyre pressure in bar for body weight		
	about 60 kg	about 80 kg	about 110 kg
25 mm	6.0	7.0	8.0
28 mm	5.5	6.5	7.5
32 mm	4.5	5.5	6.5
37 mm	4.0	5.0	6.0
40 mm	3.5	4.5	6.0
47 mm	3.0	4.0	5.0
50 mm	2.5	4.0	5.0
55 mm	2.0	3.0	4.0
60 mm	2.0	3.0	4.0

Table 34: Recommended tyre pressure for Schwalbe

- 2 Perform a visual check on tyres.



Figure 81: Correct tyre pressure. The tyre is barely deformed under the load of the body weight



Figure 82: Much too little tyre pressure

6.5.9 Brake

The brake lever grip distance can be adjusted to ensure that it can be reached more easily. The pressure point can also be adjusted to the rider's preferences.

6.5.9.1 Brake handle position

Having the brake handle in the correct position prevents the rider from stretching their wrist too far. Moreover, the brake can also be operated without any discomfort and without changing the handle position or releasing the handle.

- ✓ Apply the brake lever with the third finger phalanx to brake gently in bursts.
 - ✓ The setting for the middle finger is used for riders who brake with their middle finger or with two fingers.
- 1 Position your hand on the handle in such a way that the outer heel of the hand is flush with the end of the handlebar.
 - 2 Extend the index finger (about 15°).

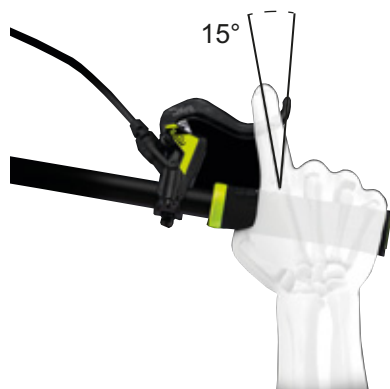

Figure 83: Brake handle position

- 3 Push brake lever outwards until the third finger phalanx sits in the brake lever recessed grip.

6.5.9.2 Brake handle tilt angle

The nerves that pass through the carpal tunnel are connected to the thumb and the index and middle fingers. An excessively steep or excessively flat brake angle will cause the wrist to bend, thus narrowing the carpal tunnel. This can cause numbness and tingling in the thumb and index and middle fingers.

- 1 Calculate the difference between the height of the handlebars and the saddle height to determine the saddle-handlebar height difference.

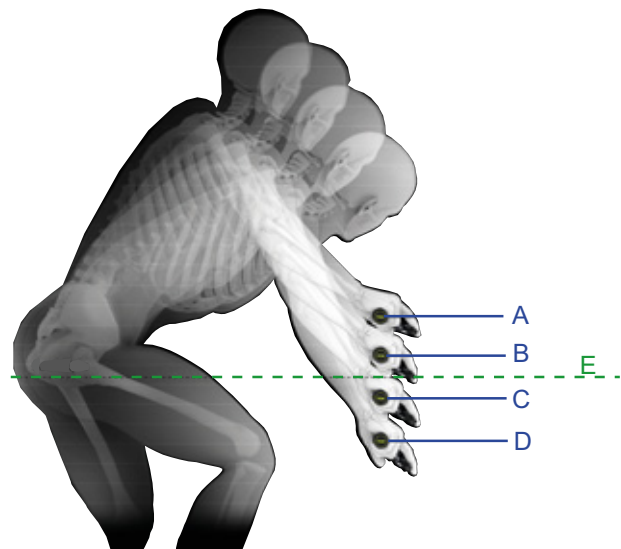

Figure 84: Example of 4 different handlebar heights (A, B, C and D) and the saddle height (E)

Calculation	Saddle-handlebar height difference [mm]
A – E	>10
B – E	0...10
C – E	0 ...-10
D – E	<-10

Table 35: Examples of saddle-handlebar height difference

Adjust the angle of the brake levers so that they form a natural extension of the forearm.

- 2 Set the brake lever angle as indicated in the table.

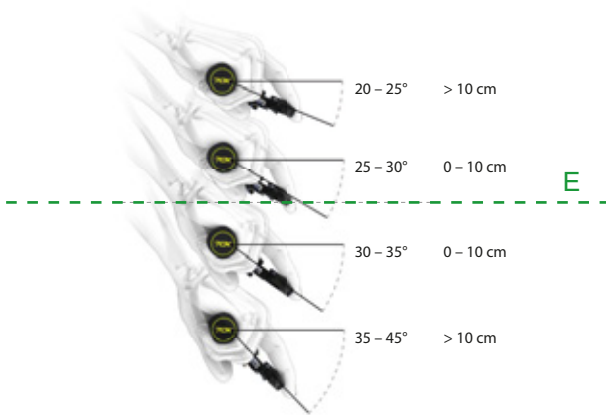

Saddle-handlebar height difference (mm)	Brake angle
>10	20°...25°
0...10	25°...30°
0...-10	30°...35°
< -10	35°...45°

Figure 85: Brake angle

6.5.9.3 Determining the grip distance

- 1 Measure hand size using the grip distance gauge.
- 2 Adjust the grip distance at the pressure point based on the hand size.



Hand size	Grip distance (cm)
S	2
M	3
L	4

Figure 86: Brake lever position

6.5.9.4 Retracting the brake linings

Disc brakes require wearing-in time. The braking force increases over time. The braking force is increased during break-in time. This is also the case when the brake pads or brake discs are replaced.

- 1** Accelerate pedelec to 25 km/h.
- 2** Brake pedelec until it comes to a halt.
- 3** Repeat process 30 to 50 times.

The disc brake is retracted and provides optimal braking power.

6.5.10 Tyres

It is not possible to offer a general recommended tyre pressure for a particular pedelec or tyre. The correct tyre pressure largely depends on the weight load on the tyres, mainly determined by body weight and baggage.

Unlike cars, the weight of the vehicle has only a small impact on the total weight. Moreover, the personal preferences for low rolling resistance or a high degree of suspension comfort vary a great deal. It is important to remember that

- the higher the tyre pressure is, the lower the wear, rolling resistance and the risk of breakdown are.
- The lower the pressure in the tyre is, the greater the comfort and grip that the tyre offers is.

In the case of pedelecs used on the road, the rule is the greater the tyre pressure is, the lower the tyre rolling resistance is. The risk of breakdown is also lower when the pressure is high.

A permanently excessively low tyre pressure often leads to premature wear in the tyre. Cracking in the side wall is a typical consequence of very low tyre pressure. Abrasion is also unnecessarily high.

On the other hand, a tyre can absorb road impacts more effectively at a low pressure.

As a general rule, wide tyres are operated at a lower tyre pressure. They provide the option of exploiting the advantages of the lower tyre pressure without the serious disadvantages it causes with regard to wear, rolling resistance and breakdown protection.

- ✓ Never exceed or go below the minimum and maximum pressure limits indicated on the tyre.

- 1 Pump the tyre to the recommended tyre pressure.

Tyre width	Tyre pressure in bar for body weight		
	about 60 kg	about 80 kg	about 110 kg
25 mm	6.0	7.0	8.0
28 mm	5.5	6.5	7.5
32 mm	4.5	5.5	6.5
37 mm	4.0	5.0	6.0
40 mm	3.5	4.5	6.0
47 mm	3.0	4.0	5.0
50 mm	2.5	4.0	5.0
55 mm	2.0	3.0	4.0
60 mm	2.0	3.0	4.0

Table 36: Recommended tyre pressure for Schwalbe

- 2 Perform a visual check on tyres.



Figure 87: Correct tyre pressure. The tyre is barely deformed under the load of the body weight



Figure 88: Much too little tyre pressure

6.5.10.1 Grip distance on a SHIMANO ST-EF41 brake lever

Only applies to pedelecs with this equipment

The brake lever position can be adjusted to the rider's requirements. Such adjustment does not affect the pressure point or the position of the brake linings.

- ▶ Turn setting screw anti-clockwise towards minus (-).
- ⇒ The brake lever moves closer to the handlebar grip.
- ▶ Turn setting screw clockwise towards plus (+).
- ⇒ The brake lever moves away from the handlebar grip.

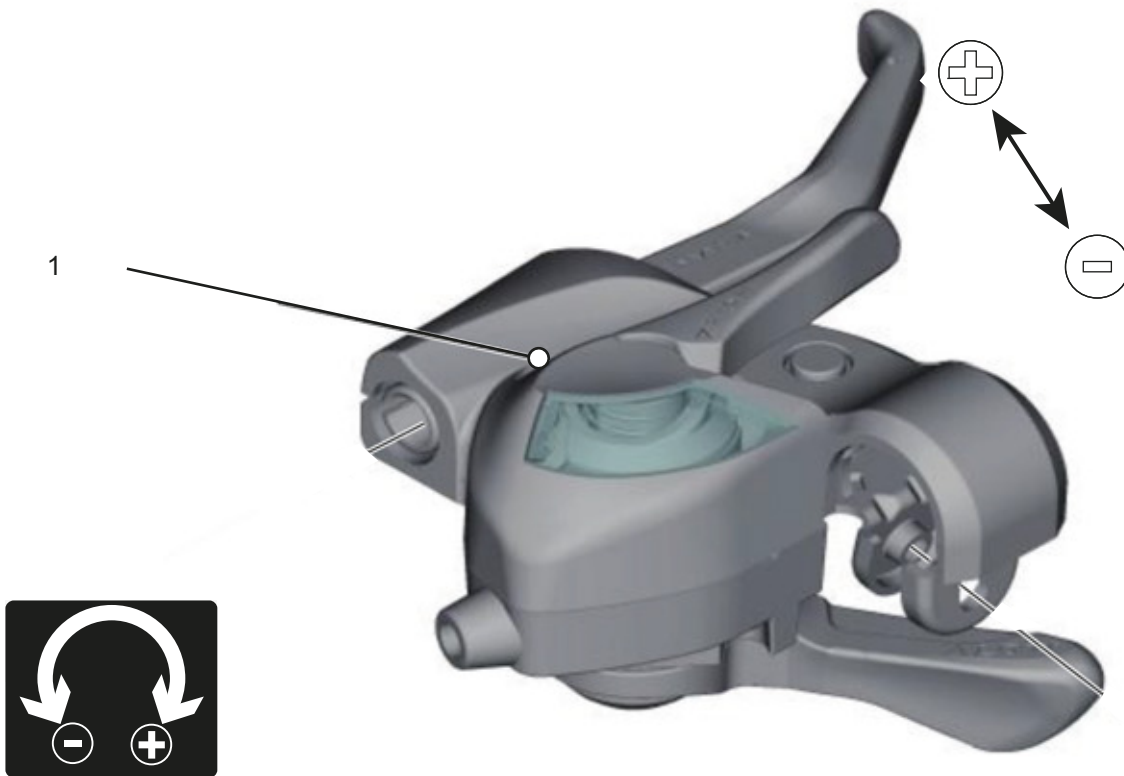

Figure 89: Setting screw position (1)

6.5.10.2 Grip distance on a SHIMANO ST-EF41 brake lever

Only applies to pedelecs with brakes:

BL-M4100

BL-M7100

BL-M8100

BL-MT200

BL-MT201

BL-MT400

BL-MT401

BL-MT402

BL-T6000

GRX ST-RX600

M7100

M8100

RS785

The brake lever position can be adjusted to the rider's requirements. Contact your specialist dealer.

6.5.11 Suspension

A pedelec's fork suspension and rear frame damper suspension can be adjusted to the rider's weight in up to six increments, depending on the suspension system.

► Follow the the correct order for adjustment.

Sequence	Adjustment	Section	For pedelecs with components only	
			Suspension fork	Rear frame damper
1	Adjust the suspension fork sag	6.3.13	x	
2	Adjust the rear frame damper sag	6.3.14		x
3	Adjust suspension fork rebound damper	6.3.15	x	
4	Adjust rear frame damper rebound damper	6.3.16		x
5	Adjust the rear frame damper compression adjuster	6.3.17		x
6	The fork compression adjuster is adjusted to the terrain while riding.	6.11		x

Table 37: Order for adjusting the suspension

6.5.12 Fork sag



Crash caused by incorrectly set suspension

If the suspension is set incorrectly, the fork may become damaged, meaning problems may occur when steering. This will cause a crash with injuries.

- Never ride the bicycle without air in the air suspension fork.
- Never use the pedelec without adjusting the suspension fork to the rider's weight.

Settings on the chassis change riding performance significantly. The rider needs to get used to the pedelec and break it in to prevent accidents.

The sag depends on the position and rider's weight and should be between 10% and 30% of the maximum fork deflection, depending on preferences and on how the pedelec is used.

Greater sag (20%...30%)

A greater sag increases sensitivity to bumps, thus producing greater suspension motion. A greater sensitivity to bumps ensures more comfortable ride performance and is used on bicycles with a longer deflection.

Decreased sag (10%...20%)

A decreased sag reduces sensitivity to bumps, thus producing less suspension motion. A lower sensitivity to bumps ensures a firmer, more efficient ride and is generally used on bicycles with a longer deflection.

The adjustment shown here represents a basic setting. The rider should change the basic setting to suit the surface and their preferences.

It is advisable to make a note of the basic settings. These can then be used as a starting point for subsequent optimised settings and as a safeguard against unintentional changes.

6.5.12.1 Adjusting the Suntour fork steel suspension

Only applies to pedelecs with this equipment

- 1 You will find the **sag setting wheel (1)** beneath the plastic cover on the crown. Remove the plastic cover.

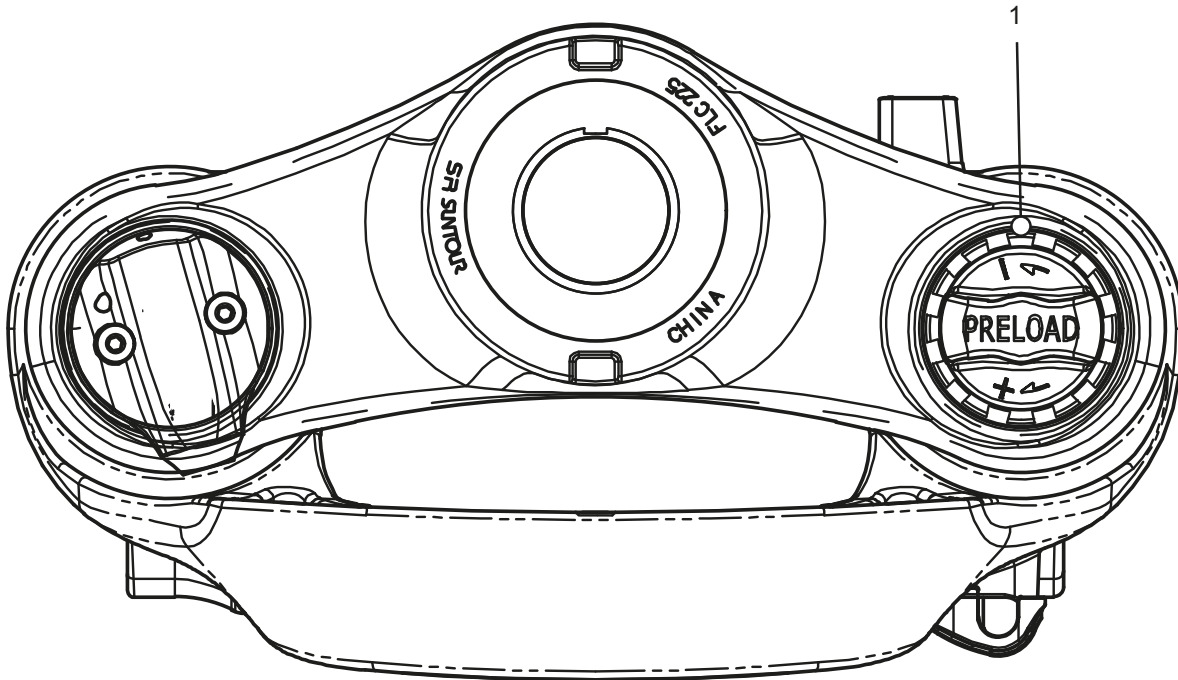

Figure 90: Sag setting wheel (1) on the suspension fork crown

- ▶ Turn the **sag setting wheel** clockwise to increase the spring pre-tensioning.
 - ▶ Turn the **sag setting wheel** anti-clockwise to decrease the spring pre-tensioning.
- ⇒ You will have made the ideal setting when the shock absorber deflects 3 mm when subject to body weight.
- 3 Replace the plastic cover on the crown after making the setting.

6.5.12.2 Adjusting the Suntour fork air suspension

Only applies to pedelecs with this equipment

- ▶ The **air valve** is located beneath the **air valve cap** on the crown. Twist off the **air valve cap**.



Figure 91: Screw caps in different designs

- 1 Attach a high-pressure damper pump to the **air valve**.
- 2 Pump air suspension fork to the required pressure. Observe the levels in the Suntour filling pressure table. Never exceed the recommended maximum tyre pressure.

Recommended air pressure (psi)						
Body weight	AION35 Mobie 45	Axon34 XCR34 XCR32	Mobie 45	NCX	XCR24	XCM-Jr.
<55 kg	35...50	40...55	40...55	40...55	40...55	40...55
55...65 kg	50...60	55...65	55...65	55...65	–	–
65...75 kg	60...70	65...75	65...75	65...75	–	–
85...95 kg	85...100	85...100	85...100	85...95	–	–
> 100 kg	+105	+100	+100	+100	–	–
Maximum air pressure	120	145	130	180	100	100

Table 38: Suntour filling pressure table for air forks

- 3 Detach high-pressure damper pump.
 - 4 Measure the distance between the crown and the dust seal. This distance is total deflection of the fork.
 - 5 Push a cable tie attached temporarily downwards against the dust seal.
 - 6 Put on your normal cycling clothing, including baggage.
 - 7 Sit on the pedelec in your usual riding position and support yourself against an object, such as a wall or tree.
 - 8 Get off the pedelec without allowing it to deflect.
 - 9 Measure distance between the dust seal and the cable tie.
- ⇒ This measurement is the sag. The recommended value is between 15% (hard) and 30% (soft) of the total fork deflection.
- 10 Increase or reduce air pressure until you have reached the desired sag.
 - 11 If the sag is correct, turn the **air valve cap** clockwise.
 - 12 If you are unable to achieve the required sag, an internal adjustment may be needed. Contact specialist dealer.

6.5.13 Fork rebound damping

Only applies to pedelecs with this equipment

Rebound damping in the suspension fork and the rear frame damper determines the speed at which the rear frame damper rebounds after being subjected to load. Rebound damping controls the suspension fork extension and rebound speed, which, in turn, has an impact on traction and control.

Rebound damping can be adjusted to body weight, spring stiffness, deflection, the terrain and the rider's preferences.

If the air pressure or spring stiffness increases, the extension and rebound speeds also increase.

Rebound damping needs to be increased to achieve an optimal setting if the air pressure or spring stiffness are increased.

The damper rebounds at a controlled speed if the fork is optimally adjusted. The wheel stays in contact with the ground when passing over bumps (blue line).

The fork head, handlebars and body follow terrain (green line) when riding over bumps. The suspension motion is predictable and controlled.

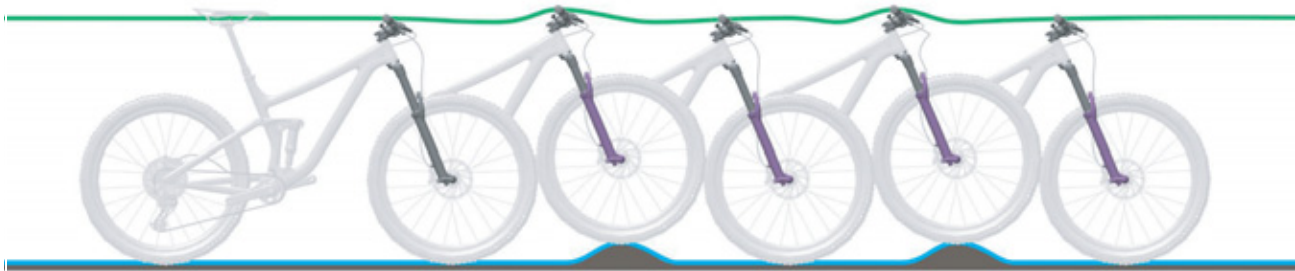
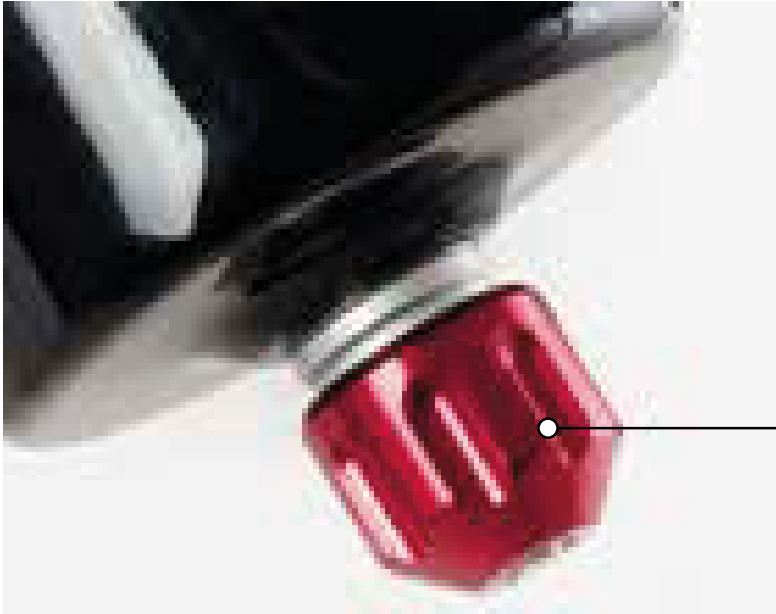

Figure 92: Optimum fork ride performance

6.5.13.1 Adjusting the Suntour fork rebound damping

Only applies to pedelecs with this equipment



1

Figure 93: Example of Suntour rebound screw (1)

- ✓ The fork sag is adjusted.
 - 1** Turn the **rebound screw** in a clockwise direction to the closed position until it stops.
 - 2** Turn the **rebound screw** slightly in an anti-clockwise direction.
- ⇒ Adjust the rebound damping in such a way that the fork rebounds quickly, but without bottoming out upwards. Bottoming out refers to when the fork rebounds too quickly and stops moving abruptly once it has reached the full rebound distance. You can hear and feel a slight impact when this happens.

6.5.14 Lighting

Example 1

If the front light is positioned too high, oncoming traffic will be dazzled. This can cause a serious accident with fatalities.

Example 2

Positioning the front light correctly can ensure that oncoming traffic is not dazzled and no-one is put at risk.

Example 3

If the front light is positioned too low, the space ahead is not illuminated to an optimum extent and the rider's vision is reduced in the dark.

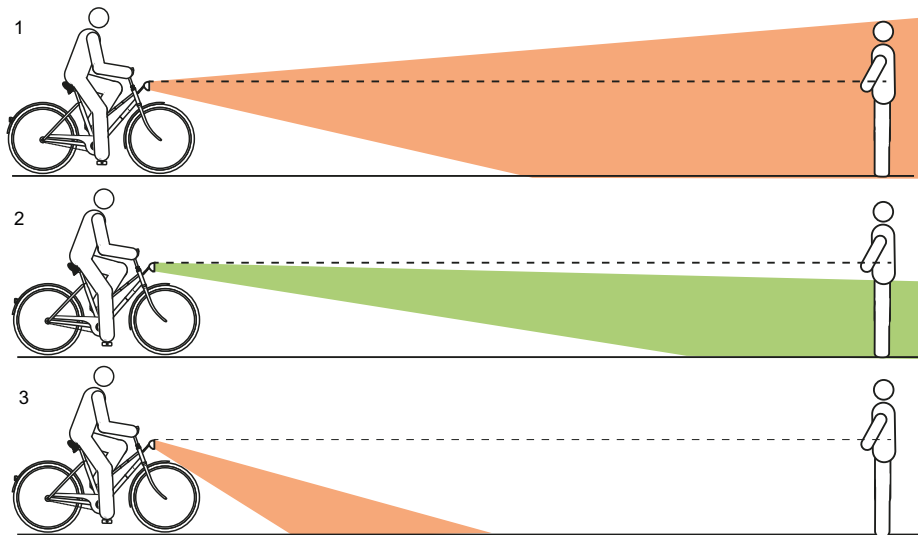

Figure 94: Light positioned too high (1), correctly (2) and too low (3)

6.5.14.1 Adjusting the lights

- 1 Position the pedelec so that its front is facing a wall.
- 2 Mark the height of the front light (1) on the wall with chalk.
- 3 Mark half the height of the front light (2) on the wall with chalk.

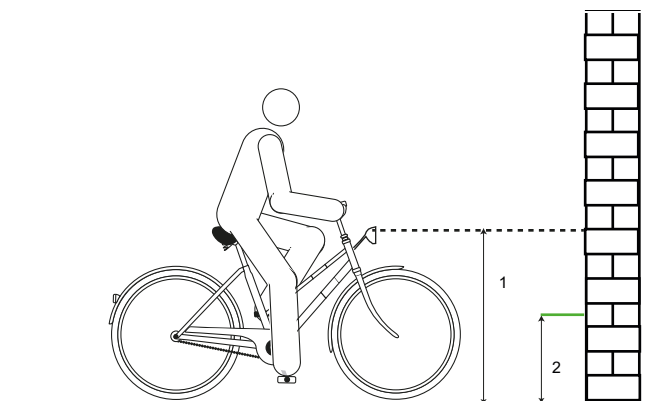

Figure 95: Front light height (1) and half the headlight height (2)

4 Place pedelec 5 m from the wall.

6 Switch on riding light.

5 Stand the pedelec up straight. Hold the handlebars straight with both hands. Do not use the kickstand.

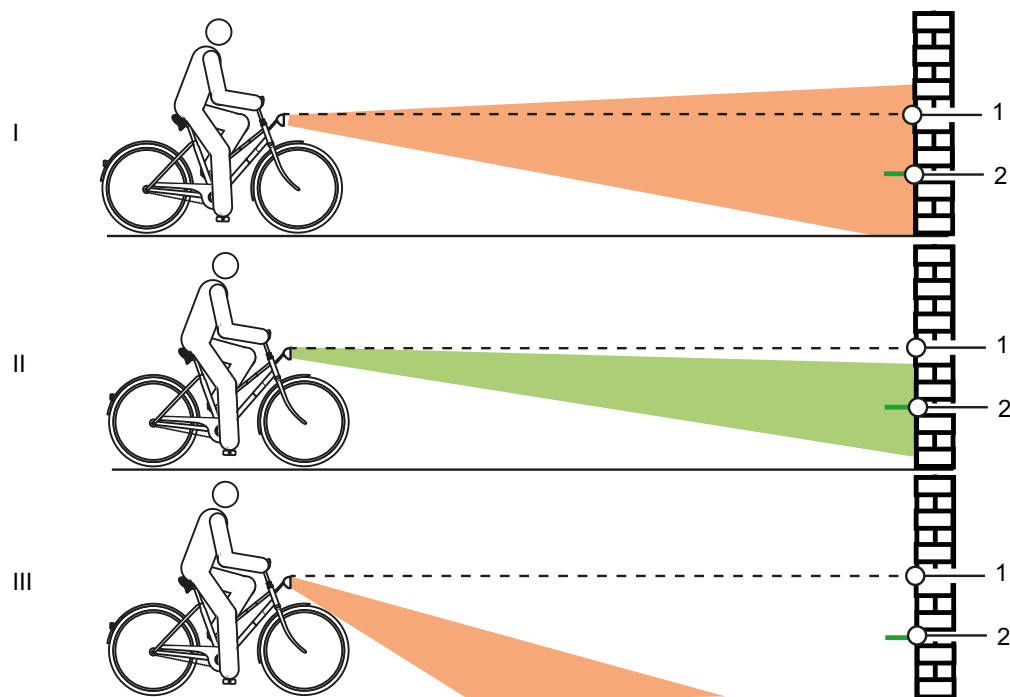

Figure 96: Light positioned too high (1), correctly (2) and too low (3)

7 Check the position of the light beam.

- ▶ (I) If the upper edge of the light beam is above the front light height mark (1), the light will dazzle. The front light must be positioned lower.
- ▶ (II) If the mid-point of the light beam is on or slightly below the mark showing half the front light (2), the light is optimally positioned.
- ▶ (III) If the light beam is in front of the wall, move front light up.

6.5.15 On-board computer

A smartphone with the eBike Flow application is required to use all drive system functions. The pedelec is connected to the app via a Bluetooth® connection.

6.5.15.1 Creating a user account

The rider needs to register online and create a user account first.

Registering on a PC

- 1 Create the user account on the BOSCH website.
- 2 Enter all the details required for registration.

Registering on a smartphone

Apple iPhones

- ▶ Download the Bosch eBike Flow smartphone app from the App Store free of charge.

Android devices

- ▶ Download the eBike Flow smartphone app from the Google Play Store free of charge.

6.5.15.2 Connecting the on-board computer with the smartphone

- ✓ The BOSCH eBike Flow app is downloaded onto the smartphone.
 - ✓ The drive system is switched on.
 - ✓ The pedelec is stationary.
- 1 Launch app.
 - 2 Select the <My eBike> tab in the app.
 - 3 Select the <Add new eBike device> tab in the app.
 - 4 Press the **On-Off button on the pedelec** for longer than 3 seconds.
 - ⇒ The top bar on the control panel battery level indicator flashes blue.
 - ⇒ The on-board computer will switch the Bluetooth® Low Energy connection on and change to pairing mode.
 - 5 Release the **On-Off button**.
 - 6 Accept the connection prompt in the app.

- 7 Follow the instructions on the display.

- ⇒ The user data will be synchronised once the pairing process is complete.

6.5.15.3 Update software

Software updates are managed by the Bosch eBike Flow smartphone app.

- ✓ The on-board computer is now connected to the smartphone.
 - ✓ The drive system is switched on.
 - ✓ The pedelec is stationary.
- ⇒ A new software update is downloaded automatically onto the on-board computer.
 - ⇒ The battery level indicator will flash green during updates to show how the update is progressing.
 - ⇒ The system is restarted after an update has completed successfully.

6.5.15.4 Activating activity tracking

- ✓ Your location will only be logged if the on-board computer is connected to the Bosch eBike Flow smartphone app.
- ▶ Agree to activities being collected and stored on the platform or in the app.
 - ⇒ All the pedelec's activities are stored and displayed on the platform and in the app.

6.5.15.5 Setting up the lock function (optional)

The user account can be used to activate the lock function. This will create a digital key on the smartphone, which is required to start the drive system.

Once the lock function is switched on, the pedelec can only be put into use if:

- the configured smartphone is switched on,
- the smartphone is charged sufficiently and
- the smartphone is directly next to the control panel.

If the key is not immediately verified on the smartphone, the battery level indicator and the display of selected support level on the pedelec flash white to indicate a search for the key.

If the key is found, the battery level indicator flashes white. The last configured level of assistance is displayed. If the key cannot be found on the smartphone, the pedelec drive system switches off. The indicators on the control panel go off.

As the smartphone is only used as a contactless key to switch on the pedelec, the battery and control panel can still be used on another, unblocked pedelec.

6.5.15.6 Inserting the display

- 1 Place display (1) on the locking hook (2) on the front edge of display mount (3) facing the direction of travel.
- 2 Press display rear onto the display mount.

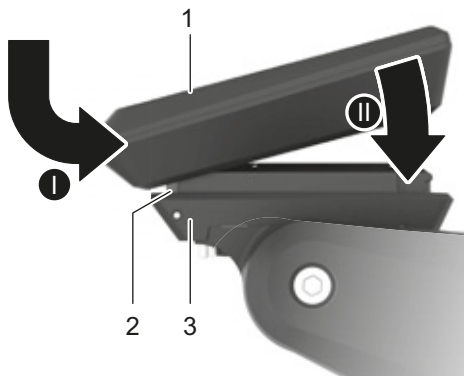

Figure 97: Inserting the display

6.5.15.7 Securing the on-board computer (optional)

It is possible to secure the on-board computer so that it cannot be removed. The locking plate does not offer theft detection.

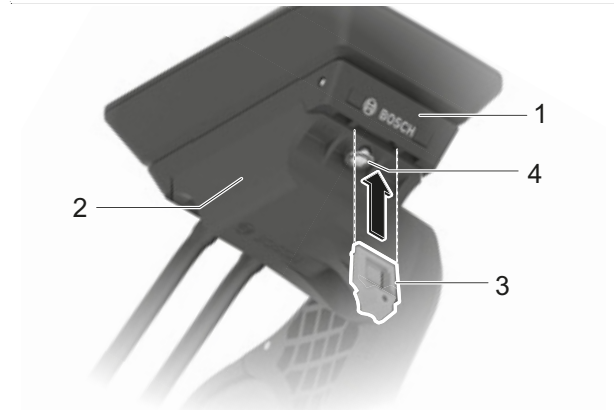

Figure 98: Position of headset screw

- 1 Insert locking plate (3) into the adapter tray (2) until you hear the locking plate lock into position.
 - ⇒ The display mount (1) can now only be removed if the two attachment screws (4) are undone.

6.5.15.8 Removing the on-board computer

- ⇒ The on-board computer can be removed if it is not secured.

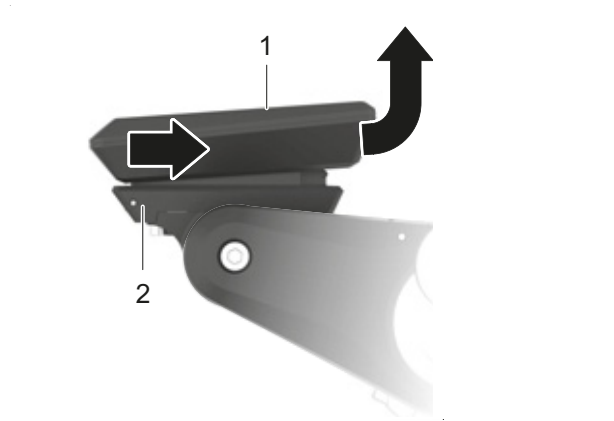

Figure 99: Removing the on-board computer

- Pull display (1) forwards until the display is lifted from the display mount (2).

6.5.15.9 Adjust on-board computer

Notice

- ▶ Never use on-board computer, the display or the display mount as a handle. If the on-board computer, display or display mount are used to lift the pedelec, components can become irreparably damaged.

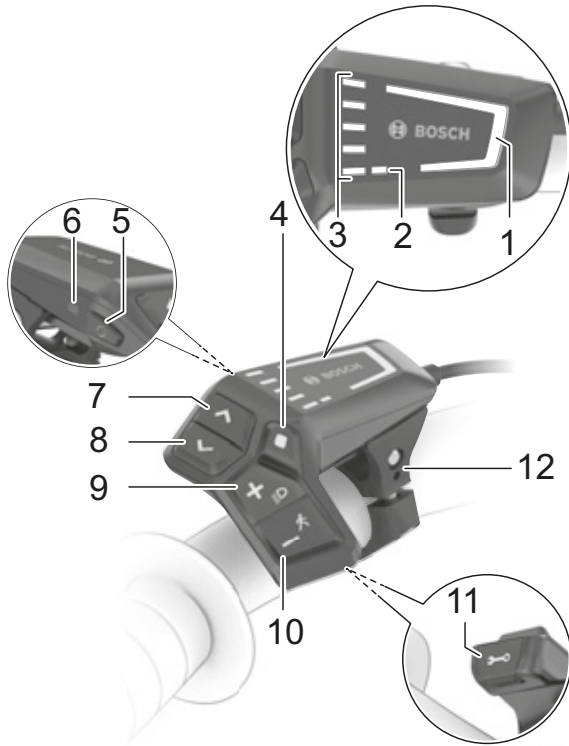

Figure 100: Overview of BOSCH LED Remote control panel

	Symbol	Designation
1		Selected level of assistance indicator
2		ABS indicator (optional)
3		Battery level indicator (control panel)
4	■	Select button
5	⏻	On-Off button (control panel)
6		Ambient light sensor
7	>	Increase brightness button/ forward button

Table 39: Overview of control panel

	Symbol	Designation
8	<	Decrease brightness button/ back button
9	+	Plus button/ light button
10	-	Minus button/ push assist button
11		Diagnosis connection (for maintenance purposes only)
12		Mount

Table 39: Overview of control panel

You can use the **select button** (4) to perform the following functions:

- Open the QUICK MENU while riding.
- Open the SETTINGS MENU on the STATUS SCREEN while the bicycle is stationary.
- Confirm values and accept information notifications
- Leave a dialogue.

You can use the **forward button** (7) and **back button** (8) to access the different user interfaces with information on ride values even when riding. This means both hands remain on the handlebars while you are cycling.

You can use the **plus button** (9) and the **minus button** (10) to increase and decrease the level of assistance. You can use the buttons to scroll up and down a list (such as the SETTINGS menu).

Open start screen

- ▶ Press **On-Off button**

⇒ The START SCREEN is displayed.

Opening the screens

- ▶ Press the **forward button** or **back button**.

⇒ A new screen is displayed.

Open Status screen

1 Open the START SCREEN.

2 Press the **Back button**.

⇒ The STATUS SCREEN is displayed.

6.5.15.10 Adjust on-board computer

- ✓ The pedelec is stationary. You cannot open and adjust the settings while riding.
- ✓ The display is inserted and shows the start screen.

- 1 Open STATUS SCREEN.
- 2 Press the **Select button**.

The settings menu is displayed.

Menu	Submenu
My eBike	→ <Range reset>
	→ <Auto trip reset [Current value]>
	→ <Wheel circumf.>
	→ <Components>
System	→ <Language>
	→ <Units>
	→ <Time>
	→ <Time format>
	→ <Brightness>
	→ <Settings reset>
Information	→ <Contact>
	→ <Certificates>

Table 40: Basic structure of Kiox300 menu and sub-menu

- ⇒ Use the **Plus** and **Minus buttons** to select the required setting.
- ▶ Press the **Select button** to confirm.
- ▶ Use the **Back button** to return to the previous menu.
- ▶ Follow the instructions on the on-board computer.

6.5.15.11 Selects the language

- 1 Open <System> menu item.
 - 2 Open <Language> sub-menu item.
 - 3 Follow the instructions on the on-board computer.
- ⇒ The language has been selected.

6.5.15.12 Adjusting the clock

- 1 Open <System> menu item.
 - 2 Open <Time> sub-menu item.
 - 3 Follow the instructions on the on-board computer.
- ⇒ The time has been set.

6.5.15.13 Adjusting the time format

- 1 Open <System> menu item.
 - 2 Open <Time format> sub-menu item.
 - 3 Follow the instructions on the on-board computer.
- ⇒ The Time Format is set.

6.5.15.14 Selecting units

- 1 Open <System> menu item.
 - 2 Open <Units> sub-menu item.
 - 3 Follow the instructions on the on-board computer.
- ⇒ The unit of speed is displayed in the selected km/h or mph format.

6.5.15.15 Setting the brightness

- 1 Open <System> menu item.
 - 2 Open <Brightness> sub-menu item.
 - 3 Follow the instructions on the on-board computer.
- ⇒ The brightness has been set.

6.5.15.16 Reset settings

- 1** Open <System> menu item.
 - 2** Open <Settings reset> sub-menu item.
 - 3** Follow the instructions on the on-board computer.
- ⇒ All settings are reset to the factory settings. All user data has been cleared.

6.6 Accessories

We recommend a parking stand into which either the front wheel or rear wheel can be inserted securely for pedelecs which do not have a kickstand. The following accessories are recommended:

Description	Article number
Protective cover for electrical components	080-41000 ff
Panniers, system component*	080-40946
Rear wheel basket, system component*	051-20603
Bicycle box, system component*	080-40947
Parking stand universal stand	XX-TWO14B

Table 41: Accessories

6.6.1 Child seat



WARNING

Crash caused by incorrect child seat

The pannier rack and down tube are unsuitable for mounting child seats and may break. Such an incorrect position may cause a crash with serious injuries for the rider or child.

- ▶ Never attach a child seat to the saddle, handlebars or down tube.



CAUTION

Crash caused by improper handling

When using child seats, the pedelec's handling characteristics and stability change considerably. This can cause a loss of control, a crash and injuries.

- ▶ You should practice how to use the child seat safely before using the pedelec in public spaces.



CAUTION

Risk of crushing due to exposed springs

The child may crush his/her fingers on exposed springs or open mechanical parts of the saddle or the seat post.

- ▶ Never install saddles with exposed springs if a child seat is being used.
- ▶ Never install seat posts with suspension with open mechanical parts or exposed springs if a child seat is being used.

Notice

- ▶ Observe the legal regulations on the use of child seats.
- ▶ Observe the operating and safety instructions for the child seat system.
- ▶ Never exceed the maximum permitted total weight.

The specialist dealer will advise you on choosing a suitable child seat system for the child and the pedelec.

The specialist dealer must install the child seat the first time to ensure that it is safely fitted.

When installing a child seat, the specialist dealer makes sure that the seat and the fastening mechanism for the seat are suitable for the pedelec and that all components are installed and firmly fastened. They will also ensure that shift cables, brake cables, hydraulic lines and electrical cables are adjusted as necessary, the rider has optimum freedom of movement and the pedelec's maximum permitted total weight is complied with.

The specialist dealer will provide instruction on how to handle the pedelec and the child seat.

6.6.2 Trailer



Crash caused by brake failure

The braking distance may be longer if the trailer is carrying excessive load. The long braking distance can cause a crash or an accident and injuries.

- ▶ Never exceed the specified trailer load.

Notice

- ▶ The *operating* and safety instructions for the trailer system must be observed.
- ▶ The statutory regulations on the use of bicycle trailers must be observed.
- ▶ Only use type-approved coupling systems.

A pedelec which is approved for towing a trailer will bear an appropriate adhesive label. You may only use trailers with a tongue load and weight which do not exceed the permitted values.

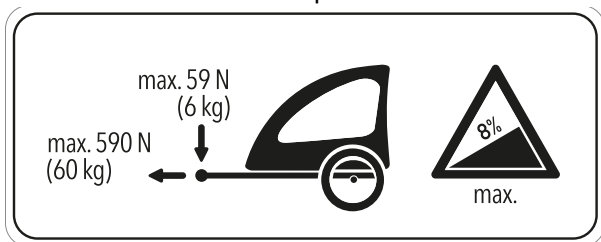

Figure 101: Trailer sign

The specialist dealer will advise on choosing a suitable trailer system for the pedelec. The specialist dealer must install the trailer the first time to ensure that it is fitted safely.

6.6.2.1 Approval for trailer with Enviolo hub

Only applies to pedelecs with this equipment

Only compatible bicycle trailers are approved for ENVIOLLO hub gears.

KETTLER

KETTLER QUADRIGA child trailer.

BURLY

Trailer	Adapter
Minnow Bee	Item no. 960038
Honey Bee	
Encore	
solo	
Cub	
D'Lite	
Normad	
Flatbed	
Tail Wagon	

CROOZER

Trailer	Adapter
Croozor Kid	Item no. 122003516, XL: +10 mm Item no. 122003716 Item no. 12200715 Croozor axle nut adapter with Thule coupling
Croozor Kid Plus	
Croozor Cargo	
Croozor Dog	

THULE

Trailer	Adapter
Thule Chariot Lite	Item no. 20100798
Thule Chariot Cab	
Thule Chariot Cross	
Thule Chariot Sport	
Thule Coaster XT	

6.6.2.2 Approval for trailer with ROHLOFF hub

Only applies to pedelecs with this equipment

ROHLOFF Speedhub 500/14

As a basic rule, it is permitted to use a trailer in combination with the ROHLOFF SPEEDHUB 500/14.

There must be **no component contact** with the cover of the ROHLOFF E-14 gear shift unit caused by pressure or tension at any time during assembly or when riding with the trailer **under any circumstances**.

Collision causing possible damage to the ROHLOFF E-14 gear shift unit can be avoided with suitable washers or special axle adapters (spacers or polygon) from the coupling manufacturer concerned.

Speedhub with A-12



Risk of an accident

The A-12 attachment screw has a very low screw-in depth. The screw or the thread in the axle plate can be damaged or ripped out if a trailer hitch is fitted directly onto the axle or the A-12 attachment screw. This may cause an accident with injuries.

- ▶ Never fit a trailer hitch directly on the axle and the A-12 attachment screw to a ROHLOFF Speedhub with an A-12 axle system in a 12 mm quick release axle frame.

6.6.3 Mobile holder

Only applies to pedelecs with this equipment

A holder for SP Connect mobile case is fitted to the stem.

- ✓ Observe the operating instructions for the mobile and the SP Connect mobile case.
- ✓ Use on tarmacked roads only.
- ✓ Protect mobile from theft.
- ▶ To attach: insert the SP Connect mobile case in the holder and turn 90° to the right.
- ▶ To release: turn the SP Connect mobile case 90° to the left and remove.

6.6.4 Tubeless and airless tyres

Bicycle riding without tubes reduces the risk of tyre punctures or even avoids them completely.

The specialist dealer will advise on choosing a suitable tyre system for the pedelec.

A specialist dealer must carry out conversion to tubeless or airless tyres for safety reasons.

6.6.5 Suspension fork coil spring

If the desired suspension fork sag cannot be achieved after adjustment, the coil spring assembly must be replaced with a softer or harder spring.

- ▶ Fit a softer coil spring assembly group to increase the sag.
- ▶ Fit a harder coil spring assembly group to decrease the sag.

6.6.6 Pannier rack

The specialist dealer will advise on choosing a suitable pannier rack.

The specialist dealer must install the pannier rack the first time to ensure that it is safely fitted.

When installing a pannier rack, the specialist dealer makes sure that the fastening mechanism is suitable for the pedelec and that all components are installed and firmly fastened. They will also ensure that shift cables, brake cables, hydraulic lines and electrical cables are adjusted as necessary, the rider has optimum freedom of movement and the pedelec's maximum permitted total weight is not exceeded.

The specialist dealer will provide instruction on how to handle the pedelec and the pannier rack.

6.6.7 Panniers and cargo boxes

- ▶ Use a paint protection film when attaching panniers. This will reduce abrasion on paint and wear on components.

6.7 Personal protective equipment and accessories for road safety

Seeing and being seen is crucial in road traffic. The following requirements must be met for riding a road-safe vehicle on public roads.

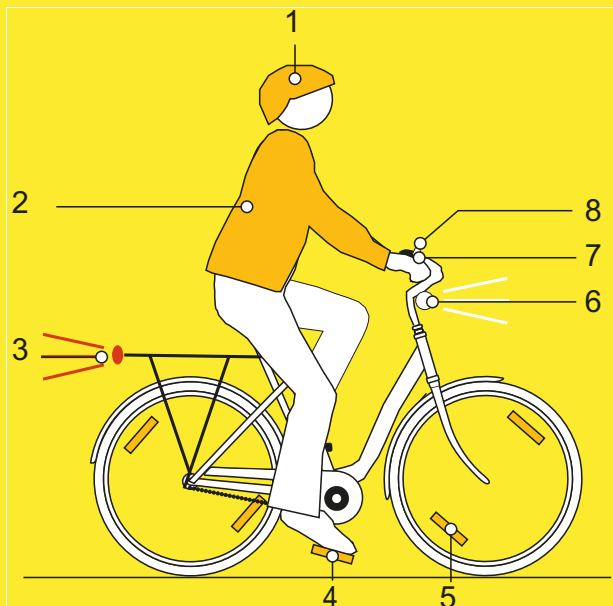

Figure 102: Road safety

- 1 The helmet must have a reflective strip or a light in a clearly visible colour.
- 2 **Cycle clothing** is essential at all times of year. Clothing should be retroreflective or as light as possible. Fluorescent materials are also suitable. High-visibility jackets and straps on your upper body ensure even greater safety. Never wear a skirt. Always wear trousers which reach down to your ankles instead.
- 3 The **large red reflector** with a “Z” registration mark and the **red rear light** must be clean. The rear light is attached high enough so that cars can see it (minimum height 25 cm). The rear light must work.
- 4 The two **reflectors on the two non-slip pedals** must be clean.
- 5 The **yellow spoke reflectors** on both wheels or the **white, fluorescent surface** on both wheels must be clean.
- 6 The **white front light** must work and must be positioned so that it does not dazzle other road users. If the **white reflector** is not integrated into the front light, it must be clean at all times.

- 7 The **two separate brakes** on the pedelec must work at all times.
- 8 The **clear sounding bell** must be fitted and must work.

6.8 Before each ride

- ▶ Check pedelec before each ride; see [section 7.1](#).

Check list before each ride		
<input type="checkbox"/>	Check everything is sufficiently clean.	See section 7.2
<input type="checkbox"/>	Check guards.	See section 7.1.1
<input type="checkbox"/>	Check battery to ensure it is firmly in place.	See section 6.7.3
<input type="checkbox"/>	Check lights.	See section 7.1.13
<input type="checkbox"/>	Check brake.	See section 7.1.14
<input type="checkbox"/>	Check suspension seat post.	See section 7.1.9
<input type="checkbox"/>	Check pannier rack.	See section 7.1.5
<input type="checkbox"/>	Check bell.	See section 7.1.10
<input type="checkbox"/>	Check handles.	See section 7.1.11
<input type="checkbox"/>	Check rear frame damper.	See section 7.1.4
<input type="checkbox"/>	Check frame.	See section 7.1.2
<input type="checkbox"/>	Check wheel concentricity.	See section 7.1.7
<input type="checkbox"/>	Check quick releases.	See section 7.1.8
<input type="checkbox"/>	Check mudguards.	See section 7.1.6
<input type="checkbox"/>	Check USB cover.	See section 7.1.12

- ▶ Be alert to any unusual noises, vibrations or odours while riding. Be alert to any unusual operating sensations when braking, pedalling or steering. This indicates material fatigue.
- ⇒ Take pedelec out of service if there are any deviations from the “Before each ride” check list or any unusual behaviour. Contact your specialist dealer.

6.9 Straightening the quickly adjustable stem

Only applies to pedelecs with this equipment

- 1 Open stem clamping lever.

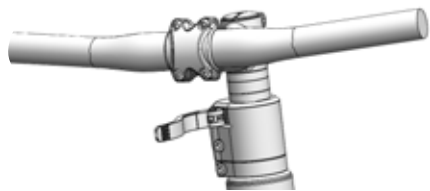

Figure 103: Example of All Up with open stem clamping lever

- 2 Pull handlebars into the highest possible position.

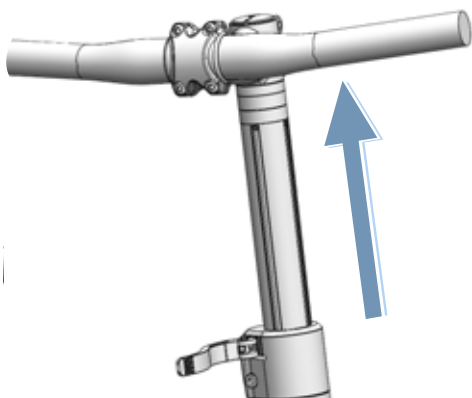

Figure 104: Example of All Up pulled into highest possible position

- 3 Turn handlebars 90° anti-clockwise so that they are straight.

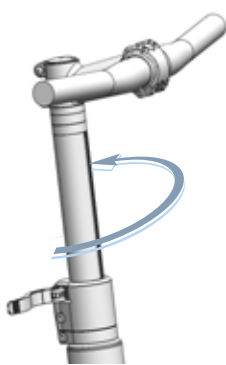

Figure 105: Example of All Up in straight position

- 4 Place handlebars at required height
- 5 Close stem clamping lever.

6.10 Using the pannier rack



Crash caused by loaded pannier rack

The pedelec is handled differently with a loaded *pannier rack*, in particular when the rider needs to steer and brake. This can lead to a loss of control. This may cause a crash with injuries.

- ▶ You should practice how to use a loaded *pannier rack* safely before using the pedelec in public spaces.

Crushing the fingers in the spring flap

The spring flap on the *pannier rack* operates with a high clamping force. There is a risk of crushing the fingers.

- ▶ Never allow the spring flap to snap shut in an uncontrolled manner.
- ▶ Be careful where you position your fingers when closing the spring flap.

Crash caused by unsecured baggage

Loose or unsecured objects on the *pannier rack*, e.g. belts, may become caught in the rear wheel. This may cause a crash with injuries.

Objects which are fastened to the *pannier rack* may cover the *reflectors* and the *riding light*. Other users may not see the pedelec on public roads as a result. This may cause a crash with injuries.

- ▶ Secure any objects which are attached to the *pannier rack* sufficiently.
- ▶ Objects fastened to the *pannier rack* must never cover the *reflectors*, the *front lamp* or the *rear light*.

- ▶ Distribute the baggage as evenly as possible between the left- and right-hand side.
- ▶ We recommend the use of panniers and baggage baskets.



Figure 106: The maximum load bearing (1) capacity is indicated on the pannier rack.

- ▶ Never exceed the maximum permitted *total weight* when packing the pannier.
- ▶ Never (1) exceed the maximum load bearing capacity of the pannier rack.
- ▶ Never modify the pannier rack.

6.11 Raising the kickstand

- ▶ Use your foot to raise kickstand completely before setting off.

6.12 Using the saddle

- ▶ Do not wear studded jeans as these can damage the saddle covering.
- ▶ Wear dark clothes for your first few rides as new leather saddles can stain clothing.

6.12.1 Using the leather saddle

Sunlight and UV light damage the colour and can cause the leather to dry out and fade.

- ▶ Do not expose the pedelec to the sun for longer periods of time.

Moisture may cause the leather to detach from material beneath and mould can form.

- ▶ If the leather handles get wet, dry handles completely.

6.13 Using the pedals

- ▶ The ball of the foot is placed on the pedal when riding and pedalling.



Figure 107: Correct (1) and incorrect (2) foot position on the pedal

6.14 Using the multifunctional handlebars or bar ends

- ▶ Vary handle position to avoid overstraining and tiring the hands.

6.14.1 Using leather handles

Sweat and grease from the skin are two of the greatest enemies of leather. They penetrate the surface of leather and cause it to disintegrate more quickly, meaning the leather can soften and abrade.

- ▶ Wear gloves.

Sunlight and UV light damage the colour and can cause the leather to dry out and fade.

- ▶ Do not expose the pedelec to the sun for longer periods of time.

Moisture may cause the leather to detach from material beneath and mould can form.

- ▶ If the leather handles get wet, dry handles completely.

6.15 Using the bell

- 1 Press the bell button downwards.
- 2 Let button spring back.

6.16 Using the battery

- ✓ Switch off the battery and the drive system before removing or inserting the battery.

6.16.1 Removing the battery

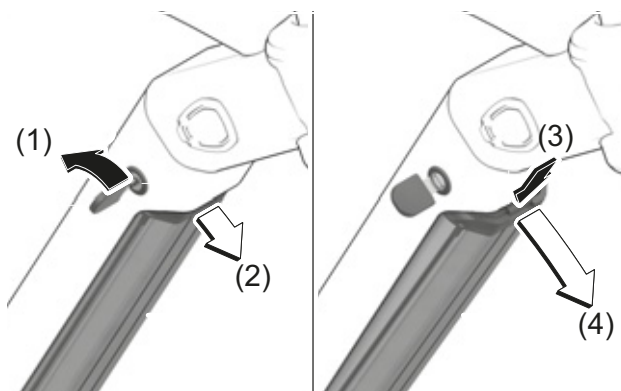

Figure 108: Removing the integrated battery

- 1 Open battery lock with battery key (1).
 - ⇒ The battery is released and falls into the retainer guard (2).
- 2 Hold the battery in your hand from below. Use the other hand to push on the retainer guard from above (3).
 - ⇒ The battery is released and falls into the hand (4).
- 3 Remove the battery from the frame.
- 4 Remove the battery key from the battery lock.

6.16.1.1 Inserting the battery

- ✓ The key is inserted in the lock.
- ✓ The lock is unlocked.

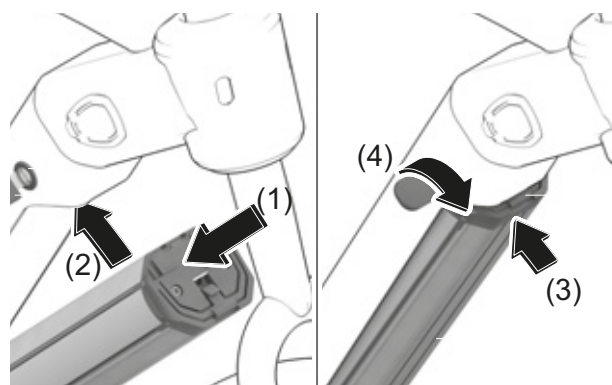

Figure 109: Inserting the integrated battery

- 1 Place the battery into the lower mount with the contacts facing the front (1).
- 2 Flip the battery upwards so that the battery is held by the retainer guard (2).
- 3 Keep the lock open with the key.
- 4 Push the battery upwards (3).
 - ⇒ The battery can be heard locking into place.
- 5 Check battery to ensure it is firmly in place on all sides.
- 6 Lock the battery with the battery key; otherwise, the battery may fall out of the mount when you open the see (4).
- 7 Remove the battery key from the battery lock.
- 8 Check the battery to ensure it is firmly in place before each ride.

6.16.2 Charging the battery

The battery can remain on the pedelec or can be removed for charging. Interrupting the charging process does not damage the battery. The battery is fitted with a temperature monitoring system which only allows charging within a temperature range between 0 °C and 40 °C.

- ✓ The ambient temperature during the charging process lies within the range between 0 °C to 40 °C.
- 1 Remove the cable connection cover if necessary.
 - 2 Connect the mains plug of the charger to a normal domestic, grounded socket.

Connection data	230 V, 50 Hz
-----------------	--------------

Notice

- ▶ Check that mains voltage! The power source voltage must match the voltage indicated on the charger nameplate. Chargers labelled 230 V may be operated at 220 V.
-
- 3 Connect the charging cable to the battery's charging port.
- ⇒ The charging process starts automatically.
 - ⇒ The battery level indicator shows the charge level during charging. When the drive system is switched on, the *on-board computer* displays the charging process.

Notice

If an error occurs during the charging process, a system message is displayed.

- ▶ Remove the charger and battery from operation immediately and follow the instructions.
-
- ⇒ The charging process is complete when the LEDs on the battery level indicator go out.

- 4 Once charging is complete, disconnect the battery from the charger.
- 5 Disconnect the charger from the mains.

6.17 Using pedelec with the electric drive system

6.17.1 Switching on the electric drive system



Crash caused by lack of readiness for braking

When it is switched on, the drive system can be activated by the application of force on the pedals. There is a risk of a crash if the drive is activated unintentionally and the brake is not reached.

- ▶ Never start the electric drive system, or switch it off immediately, if the brake cannot be reached safely and reliably.

- ✓ A sufficiently charged battery has been inserted into the pedelec.
- ✓ The battery is firmly positioned and locked. The battery key has been removed.
- ✓ The speed sensor is connected correctly.

There are two options for switching on the drive system.

On-Off button (control panel)

- ▶ Press the **On-Off button (control panel)** briefly (< 3 seconds).

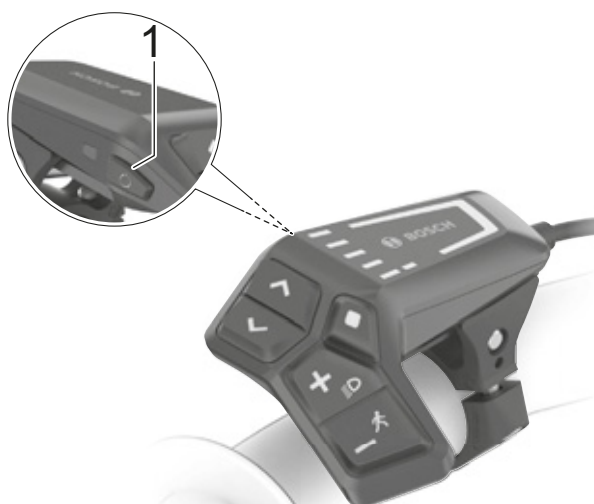

Figure 110: Position of the On-Off button on the BOSCH LED remote

On-Off button (battery)

- ▶ Press the **On-Off button (battery)** briefly.
 - ⇒ All LEDs on the control panel will light up briefly.
 - ⇒ The battery level is displayed in colour by the battery level indicator (control panel) and the configured level of assistance by the indicator for the configured level of assistance. The pedelec is ready to ride.
 - ⇒ If the battery capacity is less than 5%, the battery level indicator will remain dark. Only the control panel indicates whether the drive system is switched on or not.

If the drive system is switched on, the drive is activated as soon as the pedals are moved with sufficient force (except if the selected level of assistance is "OFF"). The motor power is based on the level of assistance selected on the control panel.

6.17.2 Switching off the electric drive system

As soon as the rider stops pushing the pedals in normal mode or reaches a speed of 25 km/h, the drive system switches off the assistance system. The assistance system starts up again when you push the pedals and your speed is less than 25 km/h.

The system switches off automatically ten minutes after the last command.

There are two options for switching off the drive system manually.

On-Off button (control panel)

- ▶ Press the **On-Off button (control panel)** briefly (< 3 seconds).

On-Off button (battery)

- ▶ Press the **On-Off button (battery)**.
 - ⇒ The battery level indicator (control panel) and the indicator for the selected level of assistance go out.
 - ⇒ The pedelec is switched off.

6.18 Using the on-board computer

Notice

- ▶ Never use on-board computer, the display or the display mount as a handle. If the on-board computer, display or display mount are used to lift the pedelec, components can become irreparably damaged.

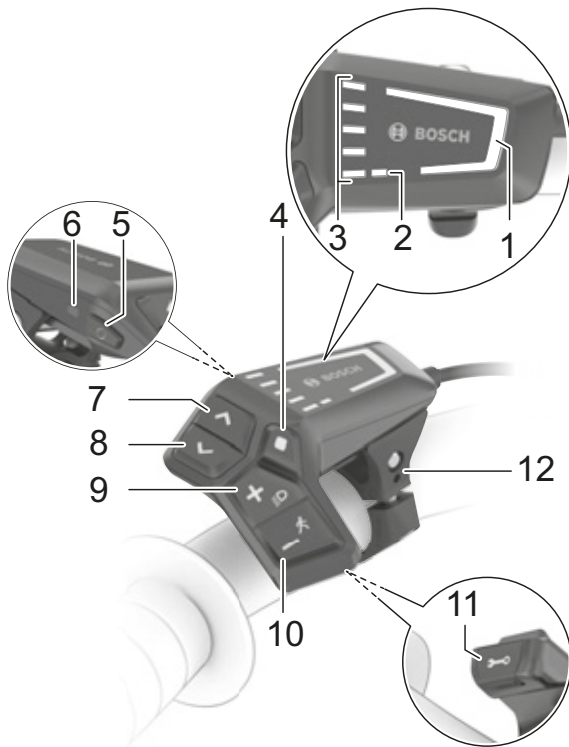

Figure 111: Overview of BOSCH LED Remote control panel

	Symbol	Designation
1		Selected level of assistance indicator
2		ABS indicator (optional)
3		Battery level indicator (control panel)
4	■	Select button
5	⏻	On-Off button (control panel)
6		Ambient light sensor

Table 42: Overview of control panel

	Symbol	Designation
7	>	Increase brightness button/ forward button
8	<	Decrease brightness button/ back button
9	+	Plus button/ light button
10	-	Minus button/ push assist button
11		Diagnosis connection (for maintenance purposes only)
12		Mount

Table 42: Overview of control panel

6.18.1 Using the diagnosis port

Notice

A USB connection is not a waterproof plug connection. Any moisture penetrating through the USB port may trigger a short circuit in the control panel.

- ▶ Never connect an external device.
- ▶ Regularly check the position of the rubber cover on the USB port and adjust it as necessary.

The diagnosis connection is only designed for maintenance purposes and is not suitable for connecting external devices.

- ▶ Keep the diagnosis port flap closed at all times to ensure no dust or moisture can penetrate through the port.

6.18.2 Charging the control panel battery

If both the charge level in the battery and the control panel's internal battery are low, the battery can be charged via the diagnosis port.

- ▶ Connect the internal battery to a power bank or another suitable power source with a USB type C® cable. (charge voltage: 5 V; charging current: max. 600 mA).

6.18.3 Using the riding light

- ✓ The drive system needs to be already switched on to turn on the *riding light*.



Figure 112: Position of riding light button (1)

- ▶ Press the **light button** for longer than 1 seconds.
- ⇒ The front light and rear light are both switched on (*riding light symbol* is displayed) and switched off (*riding light symbol* is switched off) at the same time.

6.18.4 Setting the brightness of indicators

The ambient light sensor regulates the indicator brightness.

- ✓ The ambient light sensor must be clean and must not be covered.



Figure 113: Position of increase brightness button (2) and decrease brightness button (1)

- ▶ Press the **increase brightness button** and **decrease brightness button** to set the brightness of the indicator LEDs.

6.18.5 Using the push assist system

CAUTION

Injury from pedals or wheels

The pedals and the drive wheel turn when the push assist system is used. There is a risk of injury if the pedelec wheels are not in contact with the ground when the push assist system is used (e.g. when carrying the pedelec up stairs or when placing it on a bicycle rack).

- ▶ Only use the push assist mode when pushing the pedelec.
- ▶ You must steer the pedelec securely with both hands when using push assist.
- ▶ Allow for enough freedom of movement for the pedals.

The push assist helps move the pedelec. The push assist system speed depends on the selected gear. The lower the selected gear is, the lower the speed in the push assist function is (at full power). The maximum speed is 6 km/h.

- ✓ We recommend using first gear for cycling uphill to protect the drive.



Figure 114: Position of push assist button (1)

- 1 Press **Push assist button** for longer than 1 seconds. Hold down the button.
 - ⇒ The battery level indicator goes out and a white running light in the direction of travel indicates push assist is ready.
- 2 One of the following actions must be taken within the next 10 seconds:
 - ▶ Push pedelec forwards.
 - ▶ Push pedelec backwards.
 - ▶ Make a weaving movement with the pedelec.
 - ⇒ The push assist is activated. The continuous white bars change colour to ice blue.
 - ⇒ The motor starts to push.
- 3 Release **push assist button** on the control panel to switch off push assist.
- 4 Push the **push assist button** within 10 seconds to reactivate motor assistance.
- 5 If motor assistance deactivates within 10 seconds, the push assist function switches off automatically.

Push assist will also switch off automatically if

Push will also stop if

- the rear wheel blocks
- speed bumps cannot be ridden over
- a part of the body is blocking the bicycle crank
- an obstacle turns the crank further
- the rider pedals
- the **plus button** or **On-Off button** is pressed.

The push assist mode of operation is subject to country-specific regulations and may therefore differ from the above description or may be deactivated.

6.18.6 Selecting the level of assistance

The control panel is used to set how much the electric drive should assist the rider when pedalling. You can change the level of assistance at any time while you are cycling.



Figure 115: Position of plus and minus buttons

- ▶ Press the **plus button** (2) on the control panel to increase the level of assistance.
- ▶ Press the **minus button** (1) on the control panel to reduce the level of assistance.
- ⇒ The motor power used is displayed in colour in the level of assistance indicator.

If the system is switched off, the level of assistance last displayed is saved.

6.19 Brake

WARNING

Crash caused by brake failure

Oil or lubricant on the brake disc in a disc brake or on the rim of a rim brake can cause the brake to fail completely. This may cause a crash with serious injuries.

- ▶ Never allow oil or lubricant to come into contact with the brake disc or brake linings or on the rim of a rim brake.
- ▶ If the brake linings have come into contact with oil or lubricant, contact specialist dealer to have the components cleaned or replaced.

If the brakes are applied continuously for a long time (e.g. while riding downhill for a long time), the fluid in the brake system may heat up. This may create a vapour bubble. This will cause air bubbles or water contained in the brake system to expand. This may suddenly make the lever travel wider. This may cause a crash with serious injuries.

- ▶ Release the brake regularly when riding downhill for a longer period of time.

The motor drive force is shut off during the ride as soon as the rider is no longer pedalling. The drive system does not switch off when braking.

- ▶ In order to achieve optimum braking results, do not pedal while braking.

6.19.1 Using the brake lever

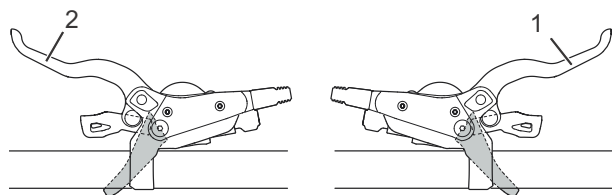

Figure 116: Brake lever, rear (1) and front (2), SHIMANO brake used as an example

- ▶ Push the left-hand *brake lever* to apply the *front wheel brake*.
- ▶ Push the right-hand *brake lever* to apply the *rear wheel brake*.
- ▶ Turn the setting wheel in an anti-clockwise direction to increase the rebound speed.
- ▶ Turn the setting wheel in a clockwise direction to decrease the rebound speed.

6.20 Gear shift

The selection of the appropriate gear is a prerequisite for a physically comfortable ride and making sure that the electric drive system functions properly. The ideal pedalling frequency is between 70 and 80 revolutions per minute.

- ▶ Stop pedalling briefly when changing gears. This makes it easier to switch gears and reduces wear on the drivetrain. However, keep the crank moving while switching gears.

6.20.1 Using the derailleur gears

Only applies to pedelecs with this equipment

The speed and range can be increased while applying the same force if you select the right gear.

- ✓ Stop pedalling briefly when changing gears. This makes it easier to switch gears and reduces wear on the drivetrain. However, keep the crank moving while switching gears.

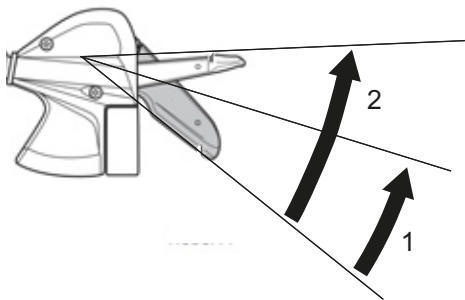

Figure 117: Switching gears with lever A, using gear shift SL-M315 as an example

Lever A switches from a smaller pinion to a larger one. The number of pinions switched depends on the selected position of lever A.

- ▶ Place shifter A in position 1.
- ⇒ System shifts one pinion higher.
- ▶ Place shifter A in position 2.
- ⇒ System shifts two pinions higher.

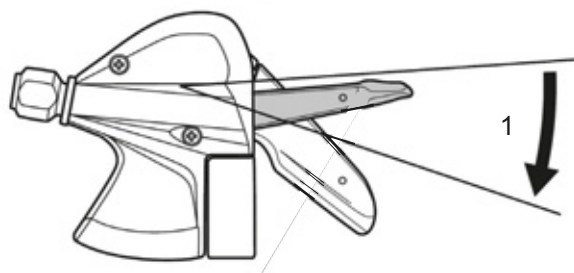

Figure 118: Switching gears with lever B, using gear shift SL-M315 as an example

Lever B switches from a larger pinion to a smaller one.

- ▶ Place shifter B in position 1.
- ⇒ System shifts one pinion lower.

Switching gears

- ▶ Select the appropriate gear with the gear shift unit.
- ⇒ The gear shift switches the gear.
- ⇒ The shifter returns to its original position.
- ▶ Clean and lubricate the rear derailleur if gear changes block.

6.21 Suspension and damping

Compression adjuster set to hard

- Causes the suspension fork to move higher within the deflection range. This improves efficiency, maintains momentum and makes it easier to ride over uniformly hilly terrain and around bends.
- Deflection may feel somewhat harder on rugged terrain.

Compression adjuster set to soft

- Causes the fork to deflect quickly and easily. This makes it easier to maintain speed and momentum when riding over uneven rugged terrain.
- Deflection feels somewhat less hard on rugged terrain.



Figure 119: Optimum performance over bumps

When optimally adjusted, the fork deflects quickly and unhindered when the bike hits bumps and absorbs a bump. Traction is retained (blue line).

The fork responds quickly to the bump. The headset and handlebars rise slightly when absorbing a bump (green line).

Threshold

The damping threshold prevents deflection until a medium impact or downward force occurs. Threshold mode increases drive efficiency over level terrain.

The threshold setting can be used to improve pedalling efficiency over flat or hilly terrain. In threshold mode, higher pedelec speeds lead to greater impact force when a pedelec hits a bump, causing the fork to deflect, and the bump is absorbed.

- When the compression adjuster is in the open position (against the stop in an anti-clockwise direction), the suspension fork deflects quickly and unhindered through its entire deflection range when an impact or downward force occurs.
- When the compression adjuster is in the threshold position, the suspension fork counteracts deflection until a medium impact or downward force occurs.
- When the compression adjuster is in the blocked position (against the stop in a clockwise direction), the suspension fork counteracts deflection throughout its deflection range until a strong impact or downward force occurs.

6.21.1 Adjusting the Suntour compression adjuster

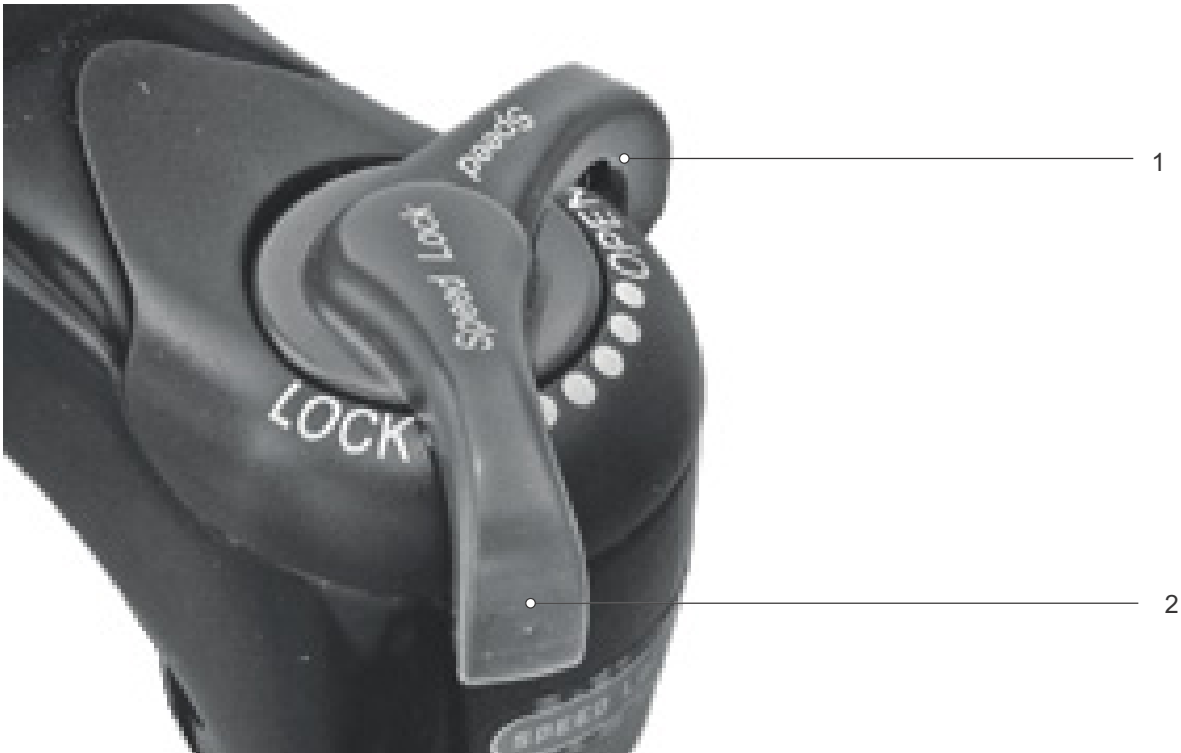

Figure 120: Suntour compression adjuster in open (1) and closed (2) position

► Place **compression adjuster** in the OPEN position.

⇒ The compression adjuster is open.

► Place **compression adjuster** in the LOCK position.

⇒ The compression adjuster is locked.

► Position **compression adjuster** between OPEN and LOCK.

⇒ This position allows you to fine-tune the compression adjuster.

We recommend setting the **compression adjuster** to the OPEN position first.

6.22 Parking

Notice

Heat or direct sunlight can cause the *tyre pressure* to increase above the permitted maximum pressure. This can destroy the *tyres*.

- ▶ Never park the pedelec in the sun.
- ▶ On hot days, regularly check the *tyre pressure* and adjust it as necessary.

Moisture penetrating at low temperatures may impair individual functions due to the open structural design.

- ▶ Always keep the pedelec dry and free from frost.
- ▶ If the pedelec is used at temperatures below 3 °C, the specialist dealer must perform maintenance beforehand and prepare it for winter use.

The pedelec's force of weight may cause the kickstand to sink into soft ground, possibly causing the pedelec to topple over as a result.

- ▶ The pedelec must be parked on firm, level ground only.

- 1 Switch off drive system (see [section 6.17.2](#)).
- 2 After getting off, use your foot to lower the kickstand completely before parking. Ensure that it is stable.
- 3 Park the pedelec carefully and check that it is stable.
- 4 Protect saddle with saddle cover if you park the pedelec outside.
- 5 Lock the pedelec with the bicycle lock.
- 6 Remove battery to protect against theft (see [section 6.16.1.1](#)).
- 7 Clean and service pedelec after every ride; see [section 7.2](#).

Check list after each ride

Cleaning		
<input type="checkbox"/>	Lights and reflectors	See section 7.2.5
<input type="checkbox"/>	Brake	See section 7.2.5
<input type="checkbox"/>	Suspension fork	See section 7.2.1
<input type="checkbox"/>	Suspension seat post	See section 7.2.6
<input type="checkbox"/>	Rear frame damper	See section 7.2.7
<input type="checkbox"/>	Pedal	See section 7.2.4
Service		
<input type="checkbox"/>	Suspension fork	See section 3

6.22.1 Screwing in the quickly adjustable stem

Only applies to pedelecs with this equipment

Screw in the All Up stem to save space when parking.

- 1 Open stem clamping lever.

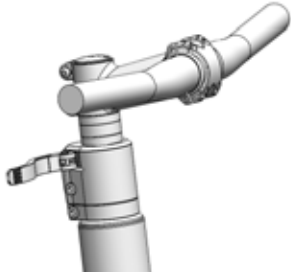

Figure 121: Example of All Up with open stem clamping lever

- 2 Pull handlebars into highest possible position.

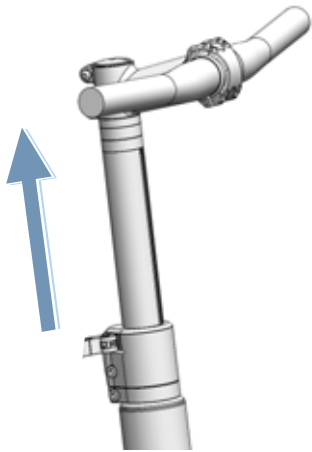

Figure 122: Example of All Up pulled into highest possible position

- 3 Turn handlebars 90° in a clockwise direction.

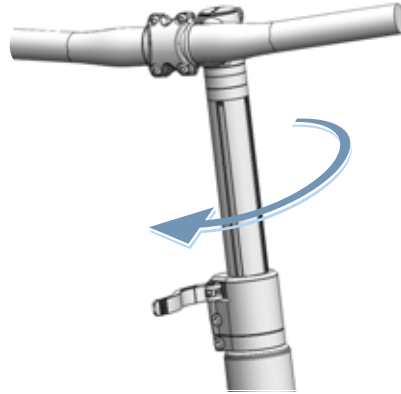

Figure 123: Example of All Up screwed in

- 4 Place handlebars at required height.
- 5 Close stem clamping lever.

6.22.2 Activating the lock function

Only applies to pedelecs with this equipment

- ▶ Remove the on-board computer used during set-up.
- ⇒ The lock function is activated. The drive system now provides no assistance. However, the rider can continue to use the pedelec without assistance.
- ⇒ The drive unit will emit a lock sound (an audible signal) as long as the drive system is switched on.
- ⇒ The lock function status is displayed with a lock icon on the on-board computer for around 3 seconds.

7 Cleaning, servicing and maintenance

- Clean, service and maintain pedelec as indicated on check list.
Complying with these measures is the only way to reduce wear on components, increase the operating hours and guarantee safety.

Check list before each ride	
<input type="checkbox"/>	Check everything is sufficiently clean see Section 7.2
<input type="checkbox"/>	Check guards see Section 7.1.1
<input type="checkbox"/>	Check battery to ensure it is firmly in place See Section 6.7.3
<input type="checkbox"/>	Check lights see Section 7.1.13
<input type="checkbox"/>	Check brake see Section 7.1.14
<input type="checkbox"/>	Check suspension seat post see Section 7.1.9
<input type="checkbox"/>	Check pannier rack see Section 7.1.5
<input type="checkbox"/>	Check bell see Section 7.1.10
<input type="checkbox"/>	Check handles see Section 7.1.11
<input type="checkbox"/>	Check rear frame damper see Section 7.1.4
<input type="checkbox"/>	Check wheel concentricity see Section 7.1.7
<input type="checkbox"/>	Check frame see Section 7.1.2
<input type="checkbox"/>	Check quick releases see Section 7.1.8
<input type="checkbox"/>	Check guards see Section 7.1.6
<input type="checkbox"/>	Check USB cover see Section 7.1.12

Check list after each ride	
<input type="checkbox"/>	Clean lights see Section 7.2.1
<input type="checkbox"/>	Clean reflectors see Section 7.2.1
<input type="checkbox"/>	Clean brake see Section 7.2.5
<input type="checkbox"/>	Clean suspension fork see Section 7.2.2
<input type="checkbox"/>	Care for suspension fork see Section 3
<input type="checkbox"/>	Clean suspension seat post see Section 7.2.6
<input type="checkbox"/>	Clean rear frame damper see Section 7.2.7
<input type="checkbox"/>	Clean the pedals see Section 7.2.4

Check list for weekly tasks	
<input type="checkbox"/>	Clean chain see Section 7.3.18
<input type="checkbox"/>	City, folding, cargo and children's bikes and bicycles for young adults When dry: every 10 days In wet conditions: every 2–6 days
<input type="checkbox"/>	Trekking and racing bikes When dry: every 140–200 km In wet conditions: every 100 km
<input type="checkbox"/>	Mountain bikes When dry: every 60–100 km In wet conditions: after every ride
<input type="checkbox"/>	Belt (every 250–300 km) see Section 7.3.17
<input type="checkbox"/>	Care for chain. See Section 7.4.16 and Section 7.4.16.1
<input type="checkbox"/>	City, folding, cargo and children's bikes and bicycles for young adults When dry: every 10 days In wet conditions: every 2–6 days
<input type="checkbox"/>	Trekking and racing bikes When dry: every 140–200 km In wet conditions: every 100 km
<input type="checkbox"/>	Mountain bikes When dry: every 60–100 km In wet conditions: maintain every time
<input type="checkbox"/>	Maintain all-round chain guard. see Section 7.4.16.1
<input type="checkbox"/>	Check tyre pressure (at least once a week) see Section 7.5.1.1
<input type="checkbox"/>	Check tyres (every 10 days) see Section 7.5.1.2
<input type="checkbox"/>	eightpins seat post Refill oil (every 20 hours) see Section 7.4.19

Check list for monthly tasks	
<input type="checkbox"/>	Cleaning the battery see Section 7.3.2
<input type="checkbox"/>	Clean control panel see Section 7.3.1
<input type="checkbox"/>	Clean on-board computer see Section 7.3.1
<input type="checkbox"/>	Check disc brake linings once a month or after braking 1,000 times see Section 7.5.2.6
<input type="checkbox"/>	Check rim brake brake linings (once a month or after braking 3000 times) see Section 7.5.1.3
<input type="checkbox"/>	Check the rim brake surface. see Section 7.5.2.6
<input type="checkbox"/>	Clean brake lever see Section 7.3.15.1
<input type="checkbox"/>	Clean brake disc see Section 7.3.16
<input type="checkbox"/>	Check brake disc see Section 7.5.2.4
<input type="checkbox"/>	Check brake Bowden cables. see Section 7.5.2.3
<input type="checkbox"/>	Clean pannier rack see Section 7.3.4
<input type="checkbox"/>	Clean handles see Section 7.3.7
<input type="checkbox"/>	Care for handles see Section 7.4.8
<input type="checkbox"/>	Check hand brake see Section 7.5.2.1
<input type="checkbox"/>	Check hydraulic system see Section 7.5.2.2
<input type="checkbox"/>	Clean cassette see Section 7.3.14
<input type="checkbox"/>	Clean chain and all-round chain guard see Section 7.3.18.1
<input type="checkbox"/>	Clean chain wheels see Section 7.3.14
<input type="checkbox"/>	Clean leather handles see Section 7.3.7.1
<input type="checkbox"/>	Care for leather handles see Section 7.4.8.2
<input type="checkbox"/>	Clean the leather saddle see Section 7.3.9.1
<input type="checkbox"/>	Care for leather saddle see Section 7.4.11
<input type="checkbox"/>	Clean handlebars see Section 7.3.6
<input type="checkbox"/>	Cleaning the motor see Section 7.3.3

Check list for monthly tasks	
<input type="checkbox"/>	Clean hub see Section 7.3.12
<input type="checkbox"/>	Cleaning the frame see Section 7.3.4
<input type="checkbox"/>	Clean tyres see Section 7.3.10
<input type="checkbox"/>	Check back-pedal brake see Section 7.5.2.5
<input type="checkbox"/>	Clean saddle see Section 7.3.9
<input type="checkbox"/>	Clean seat post see Section 7.3.8
<input type="checkbox"/>	Care for seat post see Section 7.4.9
<input type="checkbox"/>	Clean shifter see Section 7.3.13.1
<input type="checkbox"/>	Cleaning gear shift see Section 7.3.13
<input type="checkbox"/>	Clean shift cables see Section 7.3.13
<input type="checkbox"/>	Check disc brake see Section 7.5.2.4
<input type="checkbox"/>	Clean mudguard see Section 7.3.4
<input type="checkbox"/>	Clean kickstand see Section 7.3.4
<input type="checkbox"/>	Clean spokes and spoke nipples see Section 7.3.11
<input type="checkbox"/>	Care for spoke nipples see Section 7.4.13
<input type="checkbox"/>	Clean rigid fork see Section 7.3.4
<input type="checkbox"/>	Clean transmission see Section 7.3.13
<input type="checkbox"/>	Clean front derailleur see Section 7.3.14
<input type="checkbox"/>	Clean stem see Section 7.3.5

Check list for tasks every three months	
<input type="checkbox"/>	Check brake pressure point see Section 7.5.2.1
<input type="checkbox"/>	Check rim brake (100 hours trip time or every 2,000 km) see Section 7.5.2.6
<input type="checkbox"/>	Check spokes see Section 7.5.1.3

Check list for tasks to do every six months (or every 1,000 km)	
<input type="checkbox"/>	Check Bowden cables gear shift see Section 7.5.10.2
<input type="checkbox"/>	Care for brake lever see Section 7.4.18.1
<input type="checkbox"/>	Care for carbon seat post see Section 7.4.9.2
<input type="checkbox"/>	Check electric cables in gear shift see Section 7.5.10.1
<input type="checkbox"/>	Care for suspension seat post see Section 7.4.9.1
<input type="checkbox"/>	Care for rims see Section 7.4.10
<input type="checkbox"/>	Check rims see Section 7.5.1.3
<input type="checkbox"/>	Check rim hooks see Section 7.5.1.3
<input type="checkbox"/>	Care for fork see Section 7.4.2
<input type="checkbox"/>	Check gear shift see Section 7.5.10
<input type="checkbox"/>	Care for pannier rack see Section 7.4.3
<input type="checkbox"/>	Check chain see Section 7.5.8
<input type="checkbox"/>	Check derailleur gears See Section 7.5.9.1 and Section 7.5.10.3
<input type="checkbox"/>	Check chain tension see Section 7.5.9
<input type="checkbox"/>	Check wheel see Section 7.5.1
<input type="checkbox"/>	Care for handlebars see Section 7.4.7
<input type="checkbox"/>	Check handlebars see Section 7.5.5
<input type="checkbox"/>	Check light see Section 7.5.3
<input type="checkbox"/>	Care for hub see Section 7.4.12
<input type="checkbox"/>	Check hub gear see Section 7.5.9.2
<input type="checkbox"/>	Check nipple holes see Section 7.5.1.4
<input type="checkbox"/>	Care for pedals see Section 7.4.15
<input type="checkbox"/>	Check pedal see Section 7.5.7
<input type="checkbox"/>	Care for frame see Section 7.4.1
<input type="checkbox"/>	Check belt tension see Section 7.5.9
<input type="checkbox"/>	Check saddle see Section 7.5.6
<input type="checkbox"/>	Care for shifter see Section 7.4.14.2
<input type="checkbox"/>	Care for rear derailleur articulated shaft see Section 7.4.14.1
<input type="checkbox"/>	Care for rear derailleur jockey wheels see Section 7.4.14.1
<input type="checkbox"/>	Care for kickstand see Section 7.4.5
<input type="checkbox"/>	Check kickstand stability see Section 7.5.15

Check list for tasks to do every six months (or every 1,000 km)	
<input type="checkbox"/>	Check steering headset see Section 8.5.6
<input type="checkbox"/>	Servicing the stem see Section 7.4.6
<input type="checkbox"/>	Checking the stem see Section 7.5.4

Yearly or every 2,000 km	
<input type="checkbox"/>	Adjust hub with cone bearing see Section 8.5.6
<input type="checkbox"/>	Check nipple well (every 1,000 hours or every 2,000 km) see Section 7.5.1.5

 **WARNING**
Crash caused by brake failure

Oil or lubricant on the brake disc in a disc brake or on the rim of a rim brake can cause the brake to fail completely. This may cause a crash with serious injuries.

- ▶ Never allow oil or lubricant to come into contact with the brake disc or brake linings or on the rim of a rim brake.
- ▶ If the brake linings have come into contact with oil or lubricant, contact specialist dealer to have the components cleaned or replaced.
- ▶ Apply the brakes a few times to test them after cleaning, servicing or repair.

The brake system is not designed for use on a pedelec which is placed on its side or turned upside down. The brake may not function correctly as a result. This can cause a crash, which may result in injuries.

- ▶ If the pedelec is placed on its side or turned upside down, apply the brakes a couple of times before setting off to ensure they work as normal.

The brake seals are unable to withstand high pressures. Damaged brakes can fail and cause an accident with injury.

- ▶ Never clean the pedelec with a pressure washer or compressed air.

Take great care when using a hosepipe. Never point the water jet directly at the seal section.

 **CAUTION**
Crash and falling caused by unintentional activation

There is a risk of injury if the drive system is activated unintentionally.

Remove the battery before cleaning.

Notice

Water may enter the inside of the bearings if you use a steam jet. This dilutes the lubricant inside, the friction increases and, as a result, the bearings are permanently damaged in the long term. Water may also penetrate the electric components and damage them permanently.

- ▶ Never clean pedelec with a pressure washer, water jet or compressed air.

Greased parts, such as the seat post, the handlebars or the stem, may no longer be safely and reliably clamped.

- ▶ Never apply grease or oil to parts which are clamped.

Harsh cleaning agents such as acetone, methylene and trichloroethylene and solvents such as thinners, alcohol and corrosion protection can attack pedelec components and damage them permanently.

- ▶ Use approved bicycle or pedelec cleaning and care products only.

7.1 Before each ride

Complying with these cleaning instructions is the only way to reduce wear on components, increase the operating hours and guarantee safety.

7.1.1 Checking the guards

The chain or belt guards, mudguards or the motor cover can break off and go missing when the pedelec is transported or parked outside.

- ▶ Check that all guards are in place.

7.1.2 Checking the frame

- ▶ Check frame for cracks, warping and damage to the paintwork.
- ▶ If there are any cracks, warping or damage to the paintwork, remove the pedelec from service. Contact specialist dealer.

7.1.3 Checking the fork

- ▶ Check fork for cracks, warping, tarnished components, leaked oil and damage to the paintwork. Also look at hidden parts on the underside.
- ⇒ If there are any cracks, warping, tarnished components, leaked oil or damage to the paintwork, remove the pedelec from service. Contact specialist dealer.

7.1.4 Checking the rear frame damper

- ▶ Check rear frame damper for cracks, warping, tarnished components, leaked oil and damage to the paintwork. Also look at hidden parts on the underside.
- ⇒ If there are any cracks, warping, tarnished components, leaked oil or damage to the paintwork, remove the pedelec from service. Contact specialist dealer.

7.1.5 Checking the pannier rack

- 1 Hold onto pedelec by its frame. Hold onto pannier rack with the other hand.
- 2 Move the pannier rack backwards and forwards to check that all screw connections are firmly in place.
 - ⇒ Tighten loose screws.
 - ⇒ Attach loose baskets permanently with a basket bracket or cable ties.

7.1.6 Checking the guards

- 1 Hold onto pedelec by its frame. Hold onto mudguard rack with the other hand.
- 2 Move the mudguard backwards and forwards to check that all screw connections are firmly in place.
 - ⇒ Tighten loose screws.

7.1.7 Checking wheel concentricity

- ▶ Lift the front and rear wheels one after the other. and spin each wheel when lifted.
- ⇒ If the wheel is loose or is crooked when it turns, take pedelec out of service. Contact specialist dealer.

7.1.8 Checking the quick releases

- ▶ Check quick releases to ensure that all quick releases are firmly in their fully closed end position.
 - ⇒ If a quick release is not firmly in its closed end position, open quick release and place in its end position.
 - ⇒ If the quick release cannot be firmly placed in its end position, take pedelec out of service. Contact specialist dealer.

7.1.9 Checking the suspension seat post

- ▶ Deflect and let the suspension seat post rebound.
 - ⇒ If you hear unusual noises when the suspension seat post deflects and rebounds, or it yields without any resistance, take pedelec out of service. Contact specialist dealer.

7.1.10 Checking the bell

- 1 Press the bell button downwards.
 - 2 Let button spring back.
- ⇒ If you do not hear a clear, distinct ring of the bell, replace bell. Contact specialist dealer.

7.1.11 Checking the handles

- ▶ Check the handles are firmly in place.
- ⇒ Screw loose handles firmly into place.

7.1.12 Checking the USB cover

- ⇒ If featured, check the position of the *cover on the USB port* on a regular basis and adjust if necessary.

7.1.13 Checking the lighting

- 1 Switch light on.
 - 2 Check that the front and rear lights come on.
- ⇒ If the front and rear lights do not come on, take pedelec out of service. Contact specialist dealer.

7.1.14 Checking the brake

- 1 Pull both brake levers when stationary.
 - 2 Push the pedals.
- ⇒ If no resistance is generated in the usual brake lever position, take pedelec out of service. Contact specialist dealer.
- ⇒ If the brake is losing fluid, take pedelec out of service. Contact specialist dealer.

7.2 After each ride

Complying with these cleaning instructions is the only way to reduce wear on components, increase the operating hours and guarantee safety.

The following items should be ready for use to clean the pedelec after each ride:





Tool		Cleaning agent	
 Cloth	 Bucket	 Water	 Dish-washing liquid
 Brush	 Fork oil		

Table 43: Required tools and cleaning agents after each ride

7.2.1 Cleaning the lights and reflectors



- 1 Clean front light, rear light and reflectors with a damp cloth.

7.2.2 Cleaning the suspension fork



- 1 Remove dirt and deposits from the stanchions and deflector seals with a damp cloth. Check the stanchions for dents, scratches, staining or leaking oil.
- 2 Lubricate the dust seals and stanchions with a few drops of silicone spray.
- 3 Care for the suspension fork after cleaning.

7.2.3 Caring for the suspension fork



- Treat dust seals with fork oil.

7.2.4 Cleaning the pedals



- Clean pedals with a brush and soapy water.

7.2.5 Cleaning the brake



- Clean dirt on the rim and brake components with a slightly dampened cloth.

7.2.6 Cleaning the suspension seat post



- Clean dirt on the articulated joints with a slightly dampened cloth immediately after a ride.

7.2.7 Cleaning the rear frame damper



- Clean dirt on the articulated joints with a slightly dampened cloth immediately after a ride.

7.3 Basic cleaning

Complying with these basic cleaning instructions is the only way to reduce wear on components, increase the operating hours and guarantee safety.

The following are required for basic cleaning:

Tool		Cleaning agent	
			
Gloves	Toothbrush	Water	Lubricant
			
Cloth	Paintbrush	Dish-washing liquid	Brake cleaner
			
Sponge	Watering can	Degreaser	Leather cleaner
			
Brushes	Bucket		

Table 44: Required tools and cleaning agents for basic cleaning

✓ Remove battery and on-board computer before thorough cleaning.

7.3.1 On-board computer and control panel



Notice

If water enters the on-board computer, it will be permanently damaged.

- ▶ Never immerse the on-board computer in water.
- ▶ Never use a cleaning agent.

- ▶ Carefully clean the on-board computer and control panel with a soft, damp cloth.

7.3.2 Rechargeable battery



CAUTION

Risk of fire and explosion due to penetration by water

The battery is only protected from simple spray water. Penetration by water can cause a short circuit. The battery may self-ignite and explode.

- ▶ Keep contacts dry and clean.
- ▶ Never immerse the battery in water.

Notice

- ▶ Never use a cleaning agent.

- 1 Clean the battery electrical connections with a dry cloth or paintbrush only.
- 2 Wipe off the decorative sides with a damp cloth.

7.3.3 Motor



Notice

If water enters the motor, it will be permanently damaged.

- ▶ Never open the motor.
- ▶ Never immerse the motor in water.
- ▶ Never use cleaning agents.

- ▶ Carefully clean the motor on the outside with a soft, damp cloth.

7.3.4 Frame, fork, pannier rack, guards and kickstand



- 1 Soak the components with dish-washing detergent if the dirt is thick and ingrained.
- 2 After leaving it to soak for a short time, remove the dirt and mud with a sponge, brush and toothbrushes.
- 3 Rinse off the components with water from a watering can.
- 4 Wipe away oil stains with a degreaser.

7.3.5 Stem



- 1 Clean stem with a cloth and soapy water.
- 2 Rinse off component with water from a watering can.

7.3.6 Handlebars



- 1 Clean handlebars, including handles and all gears or twist grips, with a cloth and soapy water.
- 2 Rinse off component with water from a watering can.

7.3.7 Handles



- 1 Clean handles with sponge, water and soapy water.
- 2 Rinse off component with water from a watering can.
- 3 Care for rubber handles after cleaning (see [Section 7.4.8](#)).

7.3.7.1 Leather handles



Leather is a natural product and has similar properties to human skin. Regular cleaning and care help to prevent leather dehydrating, fading or becoming brittle or stained.

- 1 Remove dirt with a soft, damp cloth.
- 2 Remove stubborn stains with a leather cleaner.
- 3 Care for leather handles after cleaning (see [Section 7.4.8.2](#)).

7.3.8 Seat post



- 1 Clean seat post with a cloth and soapy water.
- 2 Rinse off component with water from a watering can.
- 3 Wipe away any grease or assembly paste residue with a cloth and degreaser.

7.3.9 Saddle



- 1 Clean the saddle with lukewarm water and a cloth dampened with soapy water.
- 2 Rinse off component with water from a watering can.

7.3.9.1 Leather saddle



Leather is a natural product and has similar properties to human skin. Regular cleaning and care help to prevent leather dehydrating, fading or becoming brittle or stained.

- 1 Remove dirt with a soft, damp cloth.
- 2 Remove stubborn stains with a leather cleaner.
- 3 Care for leather saddle after cleaning (see [Section 7.4.11](#)).

7.3.10 Tyres

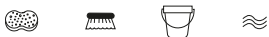

- 1 Clean tyres with a sponge, a brush and soap cleaner.
- 2 Rinse off component with water from a watering can.
- 3 Remove any embedded chips and small stones.

7.3.11 Spokes and spoke nipples

- 1 Clean spokes from the inside to the outside with a sponge, brush and soapy water.
- 2 Clean rim with a sponge.
- 3 Rinse off component with water from a watering can.
- 4 Care for spoke nipples after cleaning (see [Section 7.4.13](#)).

7.3.12 Hub



- 1 Put on protective gloves.
- 2 Remove dirt from hub with a sponge and soapy water.
- 3 Rinse off component with water from a watering can.
- 4 Wipe off oily dirt with a degreaser and a cloth.

7.3.13 Switching elements



- 1 Clean gear shift, shift cables and transmission with water, a brush and dish-washing detergent.
- 2 Rinse off component with water from a watering can.

7.3.13.1 Shifter



- ▶ Carefully clean shifter with a damp, soft cloth.

7.3.14 Cassette, chain wheels and front derailleur



- 1 Put on protective gloves.
- 2 Spray the cassette, the chain wheels and the front derailleur with a degreasing agent.
- 3 Clean coarse dirt with a brush after soaking for a short time.
- 4 Wash down all parts with dish-washing detergent and a toothbrush.
- 5 Rinse off component with water from a watering can.

7.3.15 Brake

7.3.15.1 Brake lever

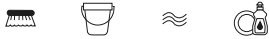

- ▶ Carefully clean the brake levers with a damp, soft cloth.

7.3.16 Brake disc



Notice

- ▶ Protect brake disc against lubricants and grease from hands.

- 1 Put on protective gloves.
- 2 Spray brake disc with brake disc cleaning spray.
- 3 Wipe with a cloth.

7.3.17 Belt



Notice

- ▶ Never use aggressive (acid-based) cleaners, rust removers or degreasers when cleaning the belt.

- 1 Dampen a cloth with soapy water. Place the cloth on the belt.
- 2 Hold and apply slight pressure while slowly turning the rear wheel, so the belt passes through the cloth.

7.3.18 Chain



Notice

- ▶ Never use aggressive (acid-based) cleaners, rust removers or degreasers when cleaning the chain.
- ▶ Never use gun oil or rust remover spray.
- ▶ Never use chain cleaning devices or chain cleaning baths.
- ▶ Have chain with all-round guard cleaned and cared for during maintenance.

- ✓ Place newspaper or paper towels underneath to collect dirt.

- 1 Slightly dampen a brush with dish-washing liquid. Brush both sides of the chain.
- 2 Dampen a cloth with soapy water. Place the cloth on the chain.
- 3 Hold and apply slight pressure while slowly turning the rear wheel, so the chain passes through the cloth.
- 4 Wipe off oily, dirty chains thoroughly with a cloth and degreaser.
- 5 Care for chain after cleaning (see [Section 7.4.16](#)).

7.3.18.1 Chain with all-round chain guard



Notice

The chain guard must be removed before cleaning. Contact specialist dealer.

- ▶ Clean water hole on the chain guard lower surface.
- ▶ Care for chain after cleaning (see [Section 7.4.16.1](#)).

7.4 Servicing

Complying with these servicing instructions is the only way to reduce wear on components, increase the operating hours and guarantee safety.

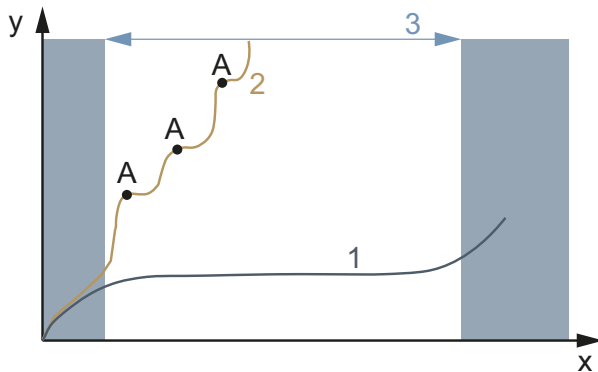

Figure 124: Diagram showing wear, operating hours (x) vs. material erosion (y)

The service life (3) of an optimally serviced drive chain (1) is almost three times as long with lubrication (A) compared to a drive chain (2) lubricated on an irregular basis.

These tools and cleaning agents are required for servicing:







Tool		Cleaning agent	
 Cloth	 Toothbrush	 Frame wax spray	 Silicone or Teflon oil
		 Acid-free lubricating grease	 Fork oil
		 Teflon spray	 Spray oil
		 Chain oil	 Leather care product

Table 45: Required tools and cleaning agents for servicing

		 Battery terminal grease	
--	--	--	--

Table 45: Required tools and cleaning agents for servicing

7.4.1 Frame



Notice

- ▶ Hard wax polish and protection wax are particularly resistant on gloss paintwork. These car accessory retail products are unsuitable for matt paint finishes.
- ▶ Try wax spray out on a small spot before application.

- 1 Dry frame with a cloth.
- 2 Spray frame with spray wax and leave to dry.
- 3 Wipe away any wax residue with a cloth.

7.4.2 Fork



Notice

- ▶ Hard wax polish and protection wax are particularly resistant on gloss paintwork. These car accessory retail products are unsuitable for matt paint finishes.
- ▶ Try wax spray out on a small spot before application.

- 1 Dry frame with a cloth.
- 2 Spray care oil on frame and leave to dry.
- 3 Wipe away any wax residue with a cloth.

7.4.3 Pannier rack



- 1 Dry pannier rack with a cloth.
- 2 Spray pannier rack with spray wax and leave to dry.
- 3 Wipe pannier rack with a cloth.
- 4 Protect chafing points on panniers with adhesive film. Replace worn adhesive film.
- 5 Care for coil springs with silicone spray or wax spray from time to time.

7.4.4 Mudguard



- Depending on the requirements for the material in the mudguard, apply hard wax polish, metal polish or a plastic care product as per the product instructions.

7.4.5 Servicing the kickstand



- 1 Dry kickstand with a cloth.
- 2 Spray kickstand rack with spray wax and leave to dry.
- 3 Wipe down kickstand with a cloth.
- 4 Lubricate the kickstand joints with spray oil.

7.4.6 Stem



- 1 Spray painted and polished metal surfaces with wax spray and leave to dry.
- 2 Wipe away any wax residue with a cloth.
- 3 Apply silicone or Teflon oil to the stem shaft tube and the quick release lever pivot point with a cloth.

- 4 If you have a Speedlifter Twist, also apply oil to the unlocking bolt groove in the Speedlifter body.
- 5 Apply a little acid-free lubricant grease between the stem quick release lever and the sliding piece to reduce the quick release lever operating force.
- 6 If you have a stem with a cone clamp, apply a new protective layer of assembly paste onto the stem and fork steerer contact point once a year.

7.4.7 Handlebars



- 1 Spray painted and polished metal surfaces with wax spray and leave to dry.
- 2 Wipe away any wax residue with a cloth.

7.4.8 Handle

7.4.8.1 Rubber handles

- 1 Apply talcum powder to sticky rubber handles.

Notice

- Never apply talcum powder to leather or foam handles.

7.4.8.2 Leather handle



Standard leather care products keep leather smooth and resistant, brighten its appearance and improve or replace stain protection.

- 1 Try leather care product out on a less visible spot before use.
- 2 Care for leather handles with a leather care product.

7.4.9 Seat post

- 1 Carefully preserve screw connections with wax spray. In doing so, ensure that no wax is applied to the metal contact surfaces.
- 2 Replace the assembly paste protective layer on the metal contact surfaces on the seat post and seat tube every year.

7.4.9.1 Suspension seat post



- 1 Lubricate articulated joints with spray oil.
- 2 Deflect and let the suspension seat post rebound five times. Remove any surplus lubricant with a clean cloth.

7.4.9.2 Carbon seat post



Notice

Rain and puddle water can cause contact corrosion if carbon seat posts are used in an aluminium frame without protective assembly paste. It may then take a great deal of force to remove the seat post. The carbon seat post may break as a result.

- 1 Take out the carbon seat post.
- 2 Remove old assembly paste with a cloth.
- 3 Apply new assembly paste with a cloth.
- 4 Re-insert the carbon seat post.

7.4.10 Rim



- Care for chrome rims, stainless steel rims and polished aluminium with chrome or metal polish. Never care for the brake surface with polish.

7.4.11 Leather saddle



Standard leather care products keep leather smooth and resistant, brighten its appearance and improve or replace stain protection.

- 1 Try leather care product out on a less visible spot before use.
- 2 Care for leather saddle from below with a leather care product. Only care for the top of leather saddles with a leather care product if they are badly worn and dried-out.
- 3 Avoid wearing light-coloured trousers after care due to staining.

7.4.12 Hub



- 1 Apply wax spray especially around the spoke holes. In doing so, ensure that no wax is applied to brake parts.
- 2 Treat rubber seals with a cloth with one or two drops of silicone spray. Never use oil if you have disc brakes.

7.4.13 Spoke nipples



- 1 Apply wax spray onto the spoke nipples from the rim side.
- 2 Treat heavily corroded spoke nipples with a drop of penetrating of special care oil.

7.4.14 Gear shift

7.4.14.1 Rear derailleur articulated shafts and jockey wheels



- ▶ Treat front and rear derailleur articulated shafts and jockey wheels with Teflon spray.

7.4.14.2 Shifter



Notice

- ▶ Never treat shifters with degreaser or penetrating oil spray.
- ▶ Lubricate articulated joints and mechanical parts which are accessible from outside with a few drops of spray oil or precision mechanics oil.

7.4.15 Pedal



- 1 Treat pedals with spray oil. In doing so, ensure that no lubricant is applied to the pedal surfaces.
- 2 Lubricate seals and mechanical parts sparingly with a few drops of oil.
- 3 Remove any surplus lubricant with a clean cloth.
- 4 Spray metal foot rests with silicone spray.

7.4.16 Caring for the chain



- ✓ Place newspaper or paper towels underneath to collect chain oil.
- 1 Lift rear wheel.
 - 2 Turn the crank briskly in an anti-clockwise direction.
 - 3 Use slight finger pressure to the chain oil bottle to apply a wafer-thin thread of oil to the chain links. The faster the crank is turned, the thinner the threads of oil will be.

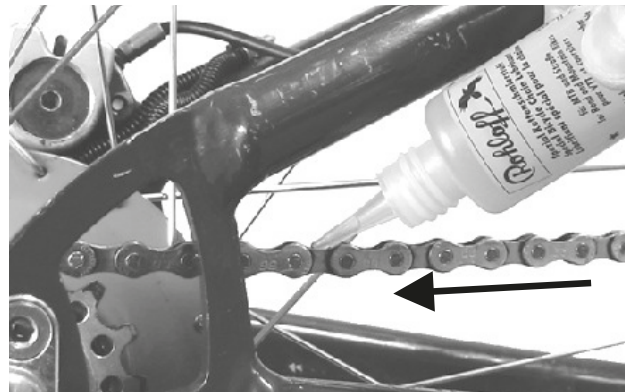

Figure 125: Lubricating the chain

- 4 Remove excessive chain oil with a cloth. If you apply too much oil, it will make the chain all the dirtier at a later point in time.
- 5 Leave chain oil to penetrate into the chain links for a few hours or overnight.

7.4.16.1 Caring for the chain and all-round chain guard



- ✓ Place newspaper or paper towels underneath to collect chain oil.
- 1 Lift rear wheel.
- 2 Turn the crank briskly in an anti-clockwise direction.
- 3 Use slight finger pressure to the chain oil bottle to apply a wafer-thin thread of oil onto the chain links through the oil hole on the upper surface of the chain guard. The faster the crank is turned, the thinner the threads of oil will be.
- 4 Remove excessive chain oil with a cloth. If you apply too much oil, it will make the chain all the dirtier at a later point in time.
- 5 Leave chain oil to penetrate into the chain links for a few hours or overnight.

7.4.17 Caring for the battery



- ▶ Grease plug terminals on the battery with terminal grease or contact spray from time to time.

7.4.18 Caring for the brake

7.4.18.1 Caring for the brake



Notice

- ▶ Never treat brake levers with degreaser or penetrating oil spray.
- ▶ Lubricate articulated joints and mechanical parts which are accessible from outside with a few drops of spray oil or precision mechanics oil.

7.4.19 Lubricating the Eightpins seat post tube

- ▶ Use a 2.5 ml syringe to carefully fill Eightpins Fluid V3 very slowly into the lubricating nipple on the outer tube.



Figure 126: Lubricating the chain

Notice

- ▶ Fill a maximum of 2.5 ml since otherwise the reservoir inside will overflow and the oil will spill into the frame.

7.5 Maintenance

The following tools are required for maintenance:









	Gloves
	Ring spanners 8 mm, 9 mm, 10 mm, 13 mm, 14 mm and 15 mm
	Torque wrench Working range 5–40 Nm
	by.schulz handlebars: TORX® bits: 4 mm, 5 mm and 6 mm If not: Hexagon bits: 4 mm, 5 mm and 6 mm
	Hexagon socket spanner 2 mm, 2.5 mm, 3 mm, 4 mm, 5 mm, 6 mm and 8 mm
	Spline nut socket T25
	Cross-recess screwdriver
	Slotted-head screwdriver

Table 46: Tools required for maintenance

7.5.1 Wheel

- 1 Hold pedelec.
- 2 Hold onto the front or rear wheel and try to move the wheel sideways. In doing so, check to see if the wheel nuts or quick releases move.
 - ⇒ If the wheel, the wheel nut or quick release moves sideways, take pedelec out of service. Contact specialist dealer.
- 3 Lift pedelec slightly. Turn front or rear wheel. In doing so, check whether the wheel deflects sideways or outwards.
 - ⇒ If the wheel deflects sideways or outwards, take pedelec out of service. Contact specialist dealer.

7.5.1.1 Checking the tyre pressure

Notice

If the tyre pressure is too low in the tyre, the tyre does not achieve its load bearing capacity. The tyre is not stable and may come off the rim.

- ▶ If the tyre pressure is too high, the tyre may burst.

Tyres are wear parts and wear away due to fatigue, storage, environmental influences or mechanical impacts. Only optimum tyre pressure will guarantee effective protection against punctures, lower rolling resistance, a longer service life and greater safety.

Air loss

Even the most airtight tube will lose pressure on a continuous basis since the air pressures in a pedelec tyre are significantly higher and the wall thicknesses significantly finer than in a car tyre. Pressure loss of 1 bar per month can be regarded as normal. During this process, the pressure loss is significantly faster at high pressures and significantly slower at low pressures.

Checking tyre pressure

The permitted pressure range is indicated on the side of the tyre.



Figure 127: Tyre pressure in bar (1) and psi (2)

- ▶ Verify tyre pressure against the value noted in the pedelec pass every 10 days as a minimum.

Dunlop valve

Only applies to pedelecs with this equipment

The tyre pressure cannot be measured on the simple Dunlop valve. The tyre pressure is therefore measured in the filling hose when pumping slowly with the bicycle pump.

✓ It is recommendable to use a bicycle pump with a pressure gauge.

- 1 Unscrew and remove the valve cap.
- 2 Undo the rim nuts.
- 3 Connect the bicycle pump.
- 4 Pump up the tyre slowly and pay attention to the tyre pressure in the process.
- 5 Correct the tyre pressure to meet the specified value in the Pedelec pass.
- 6 If the tyre pressure is too high, unfasten the union nut, let air out and re-tighten the union nut.
- 7 Remove the bicycle pump.
- 8 Screw the valve cap tight.
- 9 Screw the rim nut gently against the rim with the tips of your fingers.

⇒ Correct tyre pressure if necessary (see [Section 6.5.10](#)).

Schrader valve

Only applies to pedelecs with this equipment

✓ It is recommended to use the air pump at a filling station. Older and easy bicycle pumps are unsuitable for filling tyres via a Schrader valve.

- 1 Unscrew and remove the valve cap.
 - 1 Undo the rim nuts.
 - 2 Attach the bicycle pump.
 - 3 Pump up the tyre slowly and pay attention to the tyre pressure in the process.
- ⇒ The tyre pressure has been adjusted as per the specifications.
- 4 Remove the bicycle pump.
 - 5 Screw the valve cap tight.

- 6 Screw the rim nut gently against the rim with the tips of your fingers.

⇒ Correct tyre pressure if necessary (see [Section 6.5.10](#)).

Presta valve

Only applies to pedelecs with this equipment

✓ It is recommendable to use a bicycle pump with a pressure gauge. The operating instructions for the bicycle pump must be adhered to.

- 1 Unscrew and remove the valve cap.
- 2 Open the knurled nut around four turns.
- 3 Carefully apply the bicycle pump so that the valve insert is not bent.
- 4 Pump up the tyre slowly and pay attention to the tyre pressure in the process.
- 5 Correct the tyre pressure as per the specifications on the tyre.
- 6 Remove the bicycle pump.
- 7 Tighten the knurled nut with your fingers.
- 8 Screw the valve cap tight.
- 9 Screw the knurled nut gently against the rim with the tips of your fingers.

⇒ Correct tyre pressure if necessary (see [Section 6.5.10](#)).

7.5.1.2 Checking the tyres

The tread is far less important for bicycle tyres than it is for car tyres, for example. Consequently, tyres can still be used with a worn tread with the exception of tyres on mountain bikes.

- 1 Check the tread wear. The tyre is worn if the anti-puncture protection or the carcass cords are visible.

Since resistance to punctures also depends on the thickness of the tread, it may make sense to change the tyre at an earlier stage.



Figure 128: Tyre without tread which can still be used (1) and tyre with puncture protection showing through (2), which needs to be replaced

- 2 Check the side walls for wear. If there are any cracks or tears, the tyre must be replaced.



Figure 129: Examples of fatigue cracks (1) and ageing cracks (2)

- ⇒ Replacing a wheel requires considerable mechanical expertise. If a tyre is worn, it needs to be replaced at a specialist dealer's.

7.5.1.3 Checking the rims



Crash caused by a worn rim

A worn rim can break and block the wheel. This may cause a crash with serious injuries.

- ▶ Check rim *wear* on a regular basis.
- ▶ Take pedelec out of service if the rim has any cracks or warping. Contact specialist dealer.

Rims are wear parts and wear away due to fatigue, mechanical impacts, environmental influences or due to braking if rim brakes are used.

- ▶ Check the rim well for wear.
 - ⇒ The rims of a rim brake with invisible wear indicator are worn as soon as the wear indicator becomes visible in the area of the rim joint.
 - ⇒ The rims with visible wear indicator are worn as soon as the black, all-round groove on the pad friction surface is no longer visible. We recommend that you also replace the *rims* with every second brake lining replacement.
- ▶ We recommend that you also replace the *rims* at the same time as every second brake lining replacement.

7.5.1.4 Checking the nipple holes

Nipples cause fatigue and stress on the edge of the nipple hole.

- ▶ Check whether there are cracks on the edge of the nipple hole.

If there are cracks on the edge of the nipple hole, contact your specialist dealer.

7.5.1.5 Checking the nipple well

The nipple holes can weaken the tyre bed.

- ▶ Check to see if cracks are emerging from the nipple holes.
 - ⇒ If there are cracks radiating from the nipple hole, contact your specialist dealer.

7.5.1.6 Checking the rim hooks

Mechanical impacts can warp the rim hooks. There is no longer a guarantee that a tyre can be fitted safely if this is the case.

- ▶ Check for twisted rim hooks.
 - ⇒ Replace rims with twisted rim hooks. Never repair the rim with pliers and bend the hook back.

7.5.1.7 Checking the spokes

- ▶ Press spokes slightly together with your thumb and index finger. Check to ensure that the tension is the same for all spokes.
 - ⇒ Contact your specialist dealer if the spokes are loose or are tensioned differently.

7.5.2 Checking the brake system



Crash caused by brake failure

Worn brake discs and brake linings and a lack of hydraulic fluid in the brake line reduce the braking power. This may cause a crash with serious injuries.

- ▶ Check brake disc, brake linings and the hydraulic brake system regularly. Contact specialist dealer.

The maintenance interval for the brake depends on how often it is used and the weather conditions. If the pedelec is used under extreme conditions such as rain, dirt or high mileage, maintenance must be performed more frequently.

7.5.2.1 Checking the hand brake

- 1 Check whether all screws in the handbrake are firmly in place.
 - ⇒ Tighten loose screws.
- 2 Check whether the brake lever is torsionally rigid on the handlebars.
 - ⇒ Tighten loose screws.
- 3 Check that there is a gap of at least 1 cm between the handbrake lever and the handle when the brake lever is fully applied.
 - ⇒ Adjust the grip distance if the gap is too narrow (see [Section 6.5.9.5](#), [Section 6.5.10.1](#) or [Section 6.5.10.2](#)).
- 4 Check the braking effect by pedalling while pulling the brake lever.
 - ⇒ If the braking power is too weak, adjust the brake pressure point (see [Section 6.5.9.8](#)).
 - ⇒ Contact your specialist dealer if the pressure point cannot be reached.

7.5.2.2 Checking the hydraulic system

- 1 Push the brake lever and check whether any brake fluid leaks out of the lines, connections or on the brake linings.
 - ⇒ If any brake fluid leaks from anywhere, take pedelec out of service. Contact specialist dealer.
- 2 Push brake lever and hold several times.
 - ⇒ If you are unable to clearly detect the pressure point and it changes, the brake needs to be bled. Contact specialist dealer.

7.5.2.3 Checking the Bowden cables

- 1 Pull on the brake lever several times. Check whether the Bowden cables get stuck or they make scraping noises.
- 2 Check the physical condition of the Bowden cables for visible damage and check to see if wire strands are broken.
 - ⇒ Have defective Bowden cables replaced. Contact specialist dealer.

7.5.2.4 Checking the disc brake

Only applies to pedelecs with this equipment

Checking the brake linings

- ▶ Check that the brake linings are no less than 1.8 mm wide at any point and there are no less than 2.5 mm between the brake lining and supporting plate.



Figure 130: Checking the brake lining when fitted with the help of the transport safety wear gauge

- 1 Check brake linings for damage and thick dirt.
 - ⇒ Have damaged or very dirty brake linings replaced. Contact specialist dealer.
- 2 Push brake lever and hold.
- 3 In doing so, check whether the transport safety wear gauge can fit between the brake lining supporting plates.
 - ⇒ If the transport safety wear gauge fits between the supporting plates, the brake linings have not reached their wear limit. Contact your specialist dealer if they are worn.

Checking the brake discs

- ✓ Put on gloves as the brake disc is very sharp.
- 1 Take hold of brake disc and joggle it gently to check whether the brake disc is positioned against the wheel free of backlash.
 - 2 Check that the brake linings move uniformly and symmetrically back towards the brake disc when you pull and release the brake lever.
 - ⇒ If the brake disc can be moved or the brake linings move erratically, contact your specialist dealer.
 - 3 Check that the brake disc is no less than 1.8 mm thick at any point.
 - ⇒ If the brake disc is under the wear limit and is less than 1.8 mm thick, the brake disc must be replaced. Contact specialist dealer.

7.5.2.5 Checking the back-pedal brake

Only applies to pedelecs with this equipment

- ✓ There are sharp corners and edges on the back-pedal brake. Wear gloves.
- 1** Hold and check counter support to ensure it is firmly attached to rear frame down tube.
 - ⇒ Tighten screw into the counter support if it is loose.
- 2** Carry out brake test. Listen for noises while doing so.
 - ⇒ If braking with the backpedal makes noises, contact specialist dealer.

7.5.2.6 Checking the rim brake

Only applies to pedelecs with this equipment

Checking the brake linings

- ▶ We recommend that you also replace the *rim*s at the same time as every second brake lining replacement.
- 1 Check whether the brake linings are worn evenly on both sides of the rim.
- 2 Check whether the brake linings are worn to one side.
 - ⇒ If the brake linings are worn unevenly or worn to one side, contact your specialist dealer.
- 3 Check whether the brake lining wear limit has been reached.
 - ⇒ If the brake linings have reached their wear limit, they need to be changed. Contact specialist dealer.
- 4 Check whether the brake linings can be twisted.
 - ⇒ If the brake linings twist, the brake lining bracket is defective and must be replaced. Contact specialist dealer.
- 5 Check that the brake linings move uniformly and symmetrically towards the rim when you pull and release the brake lever.
 - ⇒ If the brake linings move unevenly, contact your specialist dealer.

Checking the rim braking surface for wear

The side wall is more prone to wear in rim brakes. The wear depends on the stress loads during rides. Dirt between the brake lining and rim and strong braking forces can have an impact on the service life.

The rim must be replaced if the wall is less than 0.9 mm thick. If deep grooves are visible, rim hooks will warp towards the outside or the braking power will change, contact your specialist dealer as soon as possible.

- ▶ Replacing a rim requires considerable mechanical expertise. Only a specialist dealer should carry out this task.

7.5.3 Checking the lighting

- 1 Check the cable connections on the front and rear lights for damage and corrosion and ensure they are firmly in position.
- ⇒ If cable connections are damaged or corroded, or are not firmly in positioned. take pedelec out of service. Contact specialist dealer.
- 2 Switch light on.
- 3 Check that the front and rear lights come on.
- ⇒ If the front or rear lights do not come on, take pedelec out of service. Contact specialist dealer.
- 4 Place pedelec 5 m from the wall.
- 5 Stand the pedelec up straight. Hold the handlebars straight with both hands. Do not use the kickstand.

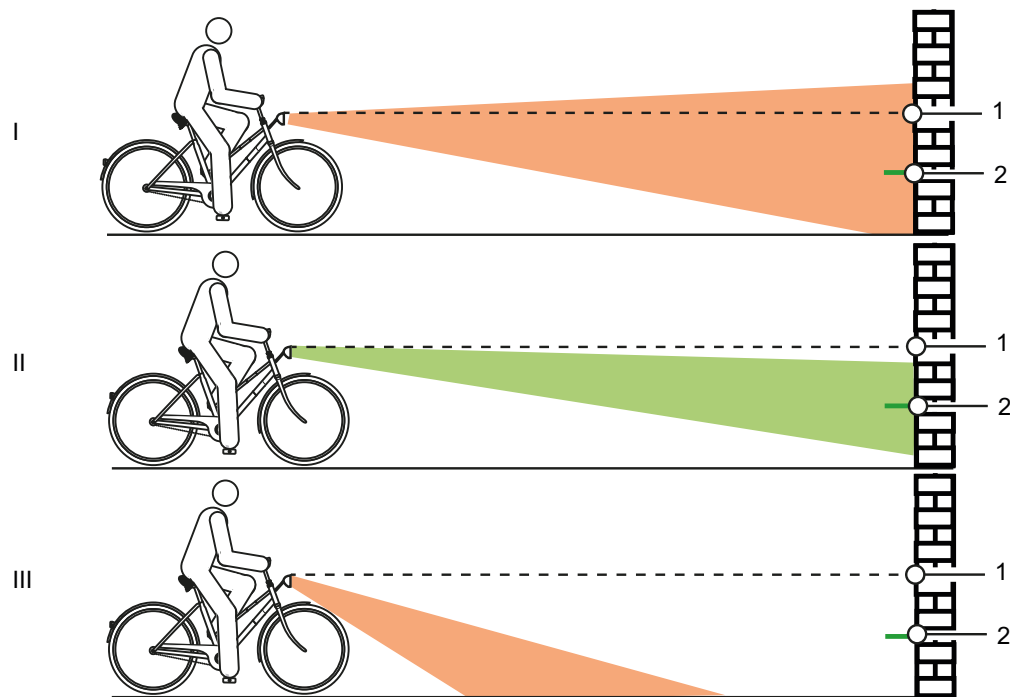

Figure 131: Light positioned too high (1), correctly (2) and too low (3)

- 6 Check the position of the light beam.
- ⇒ If the light is positioned too high or too low, adjust riding light (see [Section 6.5.14](#)).

7.5.4 Checking the stem

- ▶ The stem and quick release system must be inspected at regular intervals. The specialist dealer should adjust them if they require adjustment.
- ▶ If the hexagon socket head screw is also loosened, the headset backlash also needs to be adjusted. Medium-strength thread locker, such as Loctite blue, then needs to be applied to the loosened screws and the screws tightened as per specifications.
- ▶ Check metal contact surfaces on cone, stem clamping screw and fork steerer for corrosion.
- ⇒ Take pedelec out of service if there is any wear or signs of corrosion. Contact specialist dealer.

7.5.5 Check the handlebars

- 1 Take hold of handlebars with both hands on the handles.
 - 2 Move handlebars up and down and press to tilt.
- ⇒ If the handlebars move, contact specialist dealer.
- 3 Place front wheel in position where it can't move sideways (e.g. in a bike stand).
 - 4 Hold handlebars firmly with both hands.
 - 5 Check if the handlebars are able to twist against the front wheel.
- ⇒ If the handlebars can move, contact your specialist dealer.

7.5.6 Checking the saddle

- 1 Hold saddle firmly.
 - 2 Check whether the saddle twists, tilts or can be pushed in one direction or other.
- ⇒ If the saddle twists, tilts or can be pushed in one direction or other, adjust the saddle (see Section xxx).
 - ⇒ Contact your specialist dealer if the saddle cannot be fixed into position.

7.5.7 Checking the seat post

- 1 Take seat post out of the frame.
 - 2 Check seat post for cracks and corrosion.
 - 3 Reinsert seat post.
 - 4 Check pedal.
 - 5 Hold pedal and try to move it sideways toward the inside or outside. In doing so, observe whether the crank arm or bearing move sideways.
- ⇒ If the pedal, crank arm or crank bearing moves sideways, fasten screw on the pedal crank rear.
- 6 Hold pedal and try to move it upwards and downwards vertically. In doing so, observe whether the pedal, crank arm or crank bearing moves vertically.
- ⇒ If the pedal, crank arm or crank bearing moves vertically, fasten screw.

7.5.8 Checking the chain

- ▶ Check chain for rust or warping.
- ⇒ Replace a rusted chain since it will not be able to withstand the tensile loads from the drive. Contact your specialist retailer.

7.5.9 Checking the chain and belt tension

Notice

Excessive chain tension increases wear. If the chain tension is too low, there is a risk that the *chain* will slip off the *chain wheels*.

- ▶ Check the chain tension once a month.

- 7 If a hub gear is fitted, the rear wheel must be pushed backwards and forwards to tighten the chain. Contact specialist dealer.

7.5.9.1 Checking the derailleur gears

The chain is tensioned by the rear derailleur in pedelecs with derailleur gears.

- 1 Place the pedelec on stand.
 - 2 Check to see if the chain is sagging (visual inspection).
 - 3 Gently press the rear derailleur forwards to check whether it moves and whether it goes back into position by itself.
- ⇒ If the chain is sagging or the rear derailleur does not go back into position by itself, contact your specialist dealer.

7.5.9.2 Checking the hub gear

In the case of pedelecs with a hub gear or back-pedal brake, the chain or the belt is tensioned by a eccentric bearing in the bottom bracket axle. Special tools and specialist knowledge are required to tension the chain. Contact specialist dealer.

- ✓ Remove the chain guard on pedelecs with a circumferential chain guard.
- 1 Place the pedelec on stand.
 - 2 Check the chain and belt tension in three or four positions, turning the crank a full revolution.

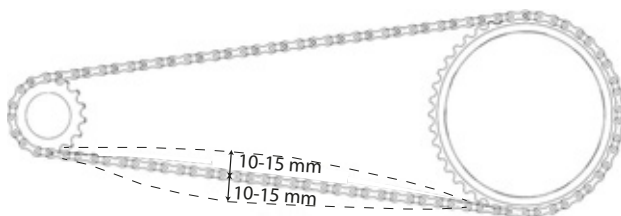

Figure 132: Checking the chain tension

- ⇒ If the chain or the belt can be pushed more than 2 cm, the chain will need to be re-tensioned. Contact specialist dealer.
- ⇒ If the chain or belt can only be pushed up and down less than 1 cm, you will need to the chain or belt slightly. Contact specialist dealer.
- ⇒ The ideal chain and belt tension has been achieved if the chain can be pushed between a maximum of 10 and 15 mm in the middle between the pinion and the toothed wheel. The crank must also turn without resistance.

7.5.10 Checking the gear shift

- 1 Check whether all gear shift components are free of damage.
- 2 Contact your specialist dealer if components are damaged.
- 3 Place the pedelec on stand.
- 4 Turn the pedal crank clockwise.
- 5 Switch through all speeds.
- 6 Check that pedelec can switch through all speeds without making unusual noises.
- 7 Adjust the gear shift if gears can not be changed correctly.

7.5.10.1 Electric gear shift

- 1 Check the cable connections for damage and corrosion and ensure they are firmly in position.
- ⇒ If cable connections are loose, damaged or corroded, contact your specialist dealer.

7.5.10.2 Mechanical gear shift

- 1 Change gear a number of times. Check whether the Bowden cables get stuck or they make scraping noises.
 - 2 Check the physical condition of the Bowden cables for visible damage and check to see if wire strands are broken.
- ⇒ Have defective Bowden cables replaced. Contact specialist dealer.

7.5.10.3 Checking the derailleur gears

- 1 Check that there is clearance between the chain tensioner and spokes.
- ⇒ If there is no clearance or the chain scrapes against the spokes or tyres, contact your specialist dealer.
- 2 Check that there is clearance between the chain or rear derailleur and spokes.
- ⇒ If there is no clearance or the chain scrapes against the spokes, contact your specialist dealer.

7.5.11 Adjusting gear shift

7.5.11.1 ROHLOFF hub

Only applies to pedelecs with this equipment

- 1 Check whether the shift cable tension is set in such a way that there is a perceptible play of around 5 mm when the shift handle is turned.
- 2 Adjust the shift cable tension by turning the tension adjuster.
 - ⇒ Unscrew the tension adjuster to increase the shift cable tension.
 - ⇒ Tighten the tension adjuster to decrease the shift cable tension.

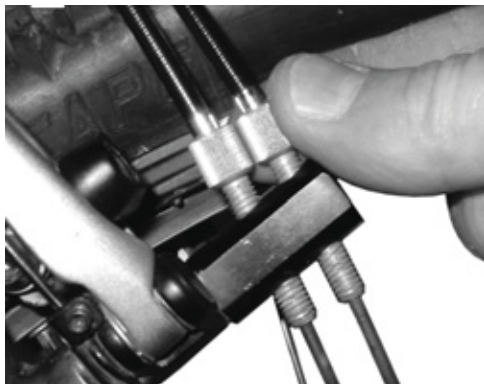

Figure 133: The tension adjuster on Rohloff hub versions with internal switch control is located on the tension counter support



Figure 134: The tension adjuster on Rohloff hub versions with external switch control is located on the cable box positioned on the left-hand side

- 3 If the marking and numbers on the shift handle do no longer coincide after the gear shift is adjusted, tighten one of the tension adjusters and screw out the other tension adjuster to the same extent.

7.5.12 Bowden-cable-operated gear shift, single-cable

Only applies to pedelecs with this equipment

- ▶ Adjust the play on the adjusting sleeves on the shifter housing to ensure a smooth gear shift.

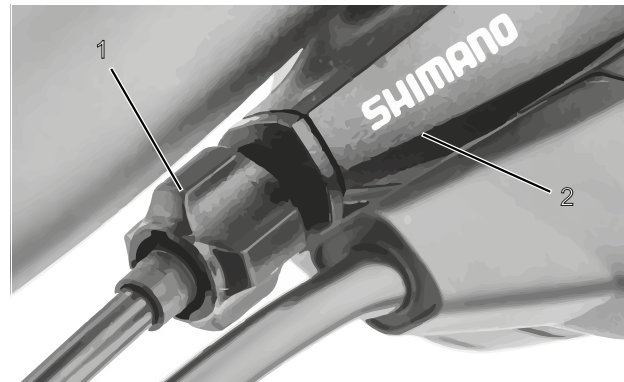

Figure 135: Adjusting sleeve (1) for the single-cable, Bowden-cable-operated gear shift with shifter housing (2), example

7.5.13 Bowden-cable-operated gear shift, dual-cable

Only applies to pedelecs with this equipment

- ▶ For a smooth gear shift, set the adjusting sleeves underneath the chain stay on the frame.
- ▶ The shift cable has around 1 mm play when it is pulled out gently.

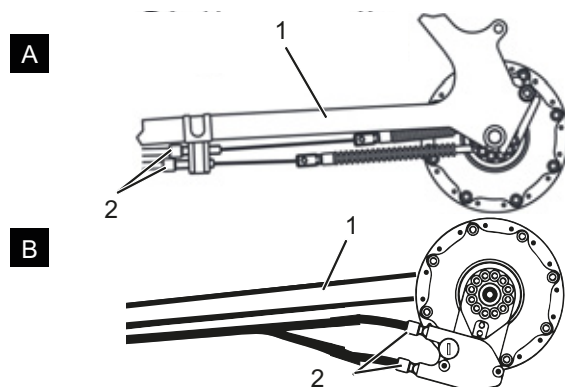

Figure 136: Adjusting sleeves (2) on two alternative versions (A and B) of a dual-cable, Bowden-cable-operated gear shift on the chain stay (1)

7.5.14 Bowden-cable-operated twist grip, dual-cable

Only applies to pedelecs with this equipment

- ▶ For a smooth gear shift, set the adjusting sleeves on the shifter housing.
- ⇒ There is noticeable play of 2 to 5 mm (1/2 gear) when you turn the twist grip.

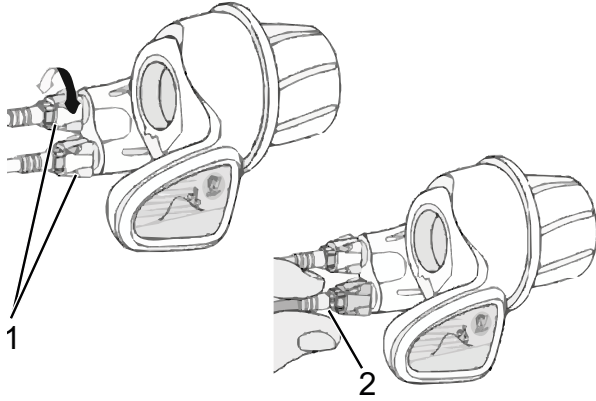

Figure 137: Twist grip with adjusting sleeves (1) and play in the gear shift (2)

7.5.15 Checking kickstand stability

- 1 Place the pedelec on a slight elevation of 5 cm.
 - 2 Extend kickstand.
 - 3 Jolt pedelec to check stability.
- ⇒ If the pedelec topples over, tighten screws or change height of the kickstand.

8 Maintenance

8.1 Initial inspection

After 200 km or 4 weeks after purchase

Vibrations produced while riding can cause screws and springs that were tightened during manufacture of the pedelec to settle or come loose.

- ▶ Arrange an appointment for the initial inspection directly when purchasing the pedelec.
- ▶ Have the initial inspection entered and stamped in the maintenance book.



- ▶ Carrying out the initial inspection, see Section 8.4.

8.2 Maintenance

Every six months

You must have your specialist dealer perform maintenance every six months as a minimum. This is the only way to ensure that the pedelec remains safe and fully functional.

Maintenance tasks require technical expertise, special tools and special lubricants. The pedelec may become damaged if the stipulated maintenance intervals and procedures are not carried out. This is why only specialist dealers may carry out maintenance.

- ▶ Contact your specialist dealer and arrange an appointment.
- ▶ Enter and stamp maintenance tasks in the maintenance book.



- ▶ Perform maintenance.

8.3 Component-specific maintenance tasks

High-quality components require extra maintenance. Maintenance tasks require technical expertise, special tools and special lubricants. The pedelec may become damaged if the stipulated maintenance intervals and procedures are not carried out. This is why only specialist dealers may carry out maintenance.

Correct maintenance on the fork not only guarantees a long service life, but also ensures optimal performance.

Each maintenance interval shows the maximum cycling hours for the required type of maintenance that the component manufacturer recommends.

- ▶ Optimise performance with shorter maintenance intervals, depending on use, terrain and environmental conditions.



- ▶ Enter any components with extra maintenance requirements with their corresponding maintenance intervals into the maintenance book when the pedelec is purchased.
- ▶ Inform the buyer of the additional maintenance schedule.
- ▶ Enter and stamp maintenance tasks in the maintenance book.

Suspension fork maintenance intervals		
Suntour suspension fork		
<input type="checkbox"/>	Maintenance 1	Every 50 hours
<input type="checkbox"/>	Maintenance 2	Every 100 hours
FOX suspension fork		
<input type="checkbox"/>	Maintenance	Every 125 hours or once a year
RockShox suspension fork		
<input type="checkbox"/>	Maintenance of stanchions for: Paragon™, XC™ 28, XC 30, 30™, Judy®, Recon™, Sektor™, 35™*, Bluto™, REBA®, SID®, RS-1™, Revelation™, PIKE®, Lyrik™, Yari™, BoXXer	Every 50 hours
<input type="checkbox"/>	Maintenance of spring and damper unit for: Paragon, XC 28, XC 30,30 (2015 and earlier), Recon (2015 and earlier), Sektor (2015 and earlier), Bluto (2016 and earlier), Revelation (2017 and earlier), REBA (2016 and earlier), SID (2016 and earlier), RS-1 (2017 and earlier), BoXXer (2018 and earlier)	Every 100 hours
<input type="checkbox"/>	Maintenance of spring and damper unit for: 30 (2016+), Judy (2018+), Recon (2016+), Sektor (2016+), 35 (2020+)*, Revelation (2018+), Bluto (2017+), REBA (2017+), SID (2017+), RS-1 (2018+), PIKE (2014+), Lyrik (2016+), Yari (2016+), BoXXer (2019+)	Every 200 hours

Maintenance intervals for suspension seat post		
by.schulz suspension seat post		
<input type="checkbox"/>	Maintenance	After the first 250 km; every 1,500 km after that
Suntour suspension seat post		
<input type="checkbox"/>	Maintenance	Every 100 hours or once a year
eightpins suspension seat post		
<input type="checkbox"/>	Clean wiper	20 hours
<input type="checkbox"/>	Clean slide bushing	40 hours
<input type="checkbox"/>	Replace slide bushing, wiper and felt strip	100 hours
<input type="checkbox"/>	Seal service for gas pressure spring	200 hours
RockShox dropper post		
<input type="checkbox"/>	Venting of remote control lever and/or maintenance of lower seat post unit for: Reverb™ A1/A2/B1, Reverb Stealth A1/A2/B1/C1*	Every 50 hours
<input type="checkbox"/>	Detach lower seat post, clean brass pins, check and replace if necessary and apply new grease for Reverb AXS™ A1*	Every 50 hours
<input type="checkbox"/>	Venting of remote control lever and/or maintenance of lower seat post unit for: Reverb B1, Reverb Stealth B1/C1*, Reverb AXS™ A1*	Every 200 hours
<input type="checkbox"/>	Complete maintenance of seat post for: Reverb A1/A2, Reverb Stealth A1/A2	Every 200 hours
<input type="checkbox"/>	Complete maintenance of seat post for: Reverb B1, Reverb Stealth B1	Every 400 hours
<input type="checkbox"/>	Complete maintenance of seat post for: Reverb AXS™ A1*, Reverb Stealth C1*	Every 600 hours
FOX suspension seat post		
<input type="checkbox"/>	Maintenance	Every 125 hours or once a year
All other suspension seat posts		
<input type="checkbox"/>	Maintenance	Every 100 hours

Maintenance intervals for rear frame damper		
RockShox rear frame damper		
<input type="checkbox"/>	Service air chamber assembly	Every 50 hours
<input type="checkbox"/>	Service damper and spring	Every 200 hours
FOX rear frame damper		
<input type="checkbox"/>	Maintenance	Every 125 hours or once a year
Suntour rear frame damper		
<input type="checkbox"/>	Complete shock absorber service including damper reassembly and air seal replacement	Every 100 hours

Maintenance intervals for hub		
SHIMANO 11-speed hub		
<input type="checkbox"/>	Internal oil change and maintenance	1,000 km after start of use, then every 2 years or 2,000 km
All other SHIMANO gear hubs		
<input type="checkbox"/>	Lubricate internal components	Once a year or every 2,000 km
ROHLOFF Speedhub 500/14		
<input type="checkbox"/>	Clean cable box and grease cable drum interior	Every 500 km
<input type="checkbox"/>	Oil change	Every 5,000 km or at least once a year
Pinion		
<input type="checkbox"/>	Maintenance 1 Check drive elements and replace if necessary Clean cable pulley, slide surfaces and gear box interior, epicyclic wheels, etc. thoroughly and grease generously	Every 500 km
<input type="checkbox"/>	Maintenance 2 Replace chain rings and change oil	Every 10,000 km

 **WARNING**
Injury due to damaged brakes

Special tools and specialist knowledge are required to repair the brakes. Incorrect or unauthorised assembly can damage the brakes. This may lead to an accident with serious injuries.

- ▶ Only specialist dealers may carry out repairs on brakes.
- ▶ Only carry out work or changes, such as dismantling, sanding or painting, which are permitted and described in the brake operating instructions.

Injury to the eyes

Problems may arise if the settings are not made properly and you may sustain serious injuries as a result.

- ▶ Always wear safety glasses during maintenance work.

 **CAUTION**
Crash and falling caused by unintentional activation

There is a risk of injury if the drive system is activated unintentionally.

- ▶ Remove the battery before maintenance.

Crash caused by material fatigue

If the service life of a component has expired, the component may suddenly fail. This may cause a crash with injuries.

- ▶ Have the specialist dealer carry out basic cleaning of the pedelec every six months, preferably at the same time as the required servicing work.

 **CAUTION**
Hazard for the environment due to toxic substances

The brake system contains toxic and environmentally harmful oils and lubricants. Such fluids will contaminate if they enter the sewers or groundwater.

- ▶ Dispose of lubricants and oils left over after repairs in an environmentally responsible way in accordance with statutory regulations.

Notice

The motor is maintenance-free and only qualified specialist personnel may open it.

- ▶ Never open the motor.

8.4 Carry out initial inspection

Vibration produced while riding can cause screws and springs that were tightened during manufacture of the pedelec to settle or come loose.

- ▶ Check quick release system is fixed in position.
- ▶ Check all tightening torques of screws and screw connections.

Incorrectly fastened screws may come loose due to impact. The stem may no longer be firmly fixed in its position as a result. This will cause a crash with injuries.

Check the handlebars and the stem quick release system are firmly in position after the first two hours of riding.



8.5 Maintenance instructions

Complying with these maintenance instructions is the only way to reduce wear on components, increase the operating hours and guarantee safety.

Diagnosis and documentation of current status

Components	Fre- quency	Description			Criteria		Measures if rejected
		Inspection	Tests	Maintenance	Accept- ance	Rejection	
Chassis							
Frame	Once a month	Dirt	...	Section 7.3.4	O.K.	Dirt	Cleaning
	6 months	Servicing	...	Section 7.4.1	O.K.	Untreated	Wax
	6 months	Check for damage – fracture, scratches	Section 8.6.1	...	O.K.	Damage detected	Take pedelec out of service, new frame as specified in parts list
Carbon frame (optional)	Once a month	Dirt	Section 7.3.4	...	O.K.	Dirt	Cleaning
	6 months	Servicing	...	Section 7.4.1	O.K.	No wax	Wax
	6 months	Damage to paintwork	Section 8.6.1.1	...	O.K.	Damage to paintwork	Apply paint
	6 months	Damage from impact	Section 8.6.1.1	...	O.K.	Damage from impact	Take pedelec out of service, new frame as specified in parts list
RockShox Rear frame damper (optional)	6 months	Check for damage, corrosion, fracture	See Rock-Shox component maintenance instructions	Maintenance as specified by manufacturer Air chamber assembly group, damper and spring.	O.K.	Damage detected	New rear frame damper as specified in parts list
FOX Rear frame damper (optional)	6 months	Check for damage, corrosion, fracture	...	Send to FOX	O.K.	Damage detected	New rear frame damper as specified in parts list
Suntour Rear frame damper (optional)	6 months	Check for damage, corrosion, fracture	See Suntour component maintenance instructions	Maintenance as specified by manufacturer Complete shock absorber service including damper reassembly and air seal replace-	O.K.	Damage detected	New rear frame damper as specified in parts list
Steering system							
Handlebars	Once a month	Cleaning	...	Section 7.3.6	O.K.	Dirt	Cleaning
	6 months	Wax	...	Section 7.4.7	O.K.	Untreated	Wax
	6 months	Check mount fastening	Section 7.5.5	...	O.K.	Loose, rust	Tighten screws; new handlebars as specified in parts list if necessary
Stem	Once a month	Cleaning	...	Section 7.3.5	O.K.	Dirt	Cleaning
	6 months	Wax	...	Section 7.4.6	O.K.	Untreated	Wax
	6 months	Check mount fastening	Section 7.5.4 and Section 8.6.4	...	O.K.	Loose, rust	Tighten screws; new stem as specified in parts list if necessary



Components	Fre-quency	Description			Criteria		Measures if rejected
		Inspection	Tests	Maintenance	Accept-ance	Rejection	
Handles	Once a month	Cleaning	...	Section 7.3.7	O.K.	Dirt	Cleaning
	Once a month	Care for	Section 7.4.8	...	O.K.	Untreated	Talcum powder
	before each ride	Wear; check if fastened securely	Section 7.1.11	...	O.K.	Missing, wobbles	Retighten screws, new handles and coverings as specified in parts list
Steering headset	6 months	Clean and check for damage	...	Clean, lubricate and adjust	O.K.	Unclean	Clean and lubricate
Fork (rigid)	6 months	Check for damage, corrosion, fracture	Dismount, check, lubricate, refit	...	O.K.	Damage detected	New fork as specified in the parts list
Carbon fork (optional)	6 months	Check for damage, corrosion, fracture	...	Maintenance as specified by manufacturer Lubrication, oil change as specified by manufacturer	O.K.	Damage detected	New fork as specified in the parts list
Suntour suspension fork (optional)	6 months	Check for damage, corrosion, fracture	...	Maintenance as specified by manufacturer Lubrication, oil change as specified by manufacturer	O.K.	Damage detected	New fork as specified in the parts list
FOX suspension fork (optional)	6 months	Check for damage, corrosion, fracture	...	Send to FOX	O.K.	Damage detected	New rear frame damper as specified in parts list
RockShox suspension fork (optional)	6 months	Check for damage, corrosion, fracture	...	Maintenance as specified by manufacturer Lubrication, oil change as specified by manufacturer	O.K.	Damage detected	New fork as specified in the parts list
Spinner suspension fork (optional)	6 months	Check for damage, corrosion, fracture	...	Maintenance as specified by manufacturer Lubrication, oil change as specified by manufacturer	O.K.	Damage detected	New fork as specified in the parts list
Wheel							
Wheel	before each ride	Concentricity	Section 7.1.7	...	O.K.	Not straight	Re-mount wheel
	6 months	Assembly	Section 7.5.1	...	O.K.	Loose	Adjust quick release
Tyres	Once a month	Cleaning	Section 7.3.10	...	O.K.	Dirt	Cleaning
	once a week	Tyre pressure	Section 7.5.1.1	...	O.K.	Tyre pressure too low/too high	Adjust tyre pressure
	10 days	Wear	Section 7.3.10	...	O.K.	Worn profile	New tyre as specified in the parts list



Components	Fre- quency	Description			Criteria		Measures if rejected
		Inspection	Tests	Maintenance	Accept- ance	Rejection	
Rims	6 months	Wax	...	Section 7.4.10	O.K.	Untreated	Wax
	6 months	Wear	Section 7.5.1.3	...	O.K.	Defective rim	New rim as specified in the parts list
	once a month	Wear on brake surface	Section 7.5.2.6	...	O.K.	Worn brake surface	New rim as specified in the parts list
Spokes	Once a month	Cleaning	...	Section 7.3.11	O.K.	Dirt	Cleaning
	3 months	Check tension	Section 7.5.1.3	...	O.K.	Loose, tension varies	Re-tension spokes or new spokes as specified in parts list
	6 months	Check rim hooks	Section 7.5.1.3	...	O.K.	Twisted rim hooks	New rim as specified in the parts list
Spoke nipples	Once a month	Cleaning	...	Section 7.3.11	O.K.	Dirt	Cleaning
	Once a month	Wax	...	Section 7.4.13	O.K.	Untreated	Wax
Nipple holes	6 months	Check for cracks	Section 7.5.1.4	...	O.K.	Cracks	New rim as specified in the parts list
Nipple well	Once a year	Check for cracks	Section 7.5.1.5	...	O.K.	Cracks	New rim as specified in the parts list
Hub	Once a month	Cleaning	...	Section 7.3.12	O.K.	Dirt	Cleaning
	Once a month	Care for	...	Section 7.4.12	O.K.	Untreated	Treat
Hub with cone bearing (optional)	Once a month	Cleaning	...	Section 7.3.12	O.K.	Dirt	Cleaning
	Once a month	Care for	...	Section 7.4.12	O.K.	Untreated	Treat
	6 months	Check mount fastening	#	...	O.K.	Loose, rust	Retighten screws; new handlebars as specified in parts list if necessary
	Once a year	Adjust	...		O.K.	Not adjusted	New position
Hub gear (optional)	Once a month	Cleaning	...	Section 7.3.12	O.K.	Dirt	Cleaning
	Once a month	Care for	...	Section 7.4.12	O.K.	Untreated	Treat
	6 months	Check mount fastening	#	...	O.K.	Loose, rust	Retighten screws; new handlebars as specified in parts list if necessary
	6 months	Functional check	Section 7.5.9.2	...		incorrect switching	Readjust hub
Saddle and seat post							
Saddle	Once a month	Cleaning		Section 7.3.9	O.K.	Dirt	Cleaning
	6 months	Check mount fastening	Section 7.5.6	...	O.K.	Loose	Retighten screws
Leather saddle (optional)	Once a month	Cleaning	...	Section 7.3.9.1	O.K.	Dirt	Cleaning
	6 months	Care for	...	Section 7.4.11	O.K.	Untreated	Leather wax
	6 months	Check mount fastening	Section 7.5.6	...	O.K.	Loose	Retighten screws



Components	Fre- quency	Description			Criteria		Measures if rejected
		Inspection	Tests	Maintenance	Accept- ance	Rejection	
Seat post	Once a month	Cleaning	...	Section 7.3.8	O.K.	Dirt	Cleaning
	6 months	Care for	...		O.K.	Untreated	Leather wax
	6 months	Complete clean, check fastening and paint protection film	...	Section 8.6.8	O.K.	Loose	Tighten screws, new paint protection film
Carbon seat post (optional)	Once a month	Cleaning	...	Section 7.3.8	O.K.	Dirt	Cleaning
	6 months	Care for	...	Section 7.4.9.2	O.K.	Untreated	Assembly paste
	6 months	Complete clean, check fastening and paint protection film	...	Section 8.6.8.1	O.K.	Loose	Tighten screws, new paint protection film; new seat post as specified in parts list if damaged
Suspension seat post (optional)	Once a month	Cleaning	...	#	O.K.	Dirt	Cleaning
	6 months	Care for	...	Section 7.4.9.1	O.K.	Untreated	Oils
	100 hours or 6 months	Complete clean, check fastening and paint protection film	Section 8.6.8	...	O.K.	Loose	Tighten screws, new paint protection film
by.schulz suspension seat post (optional)	After the first 250 km; every 1500 km after that	Complete clean, check fastening and paint protection film, lubricate	Section 8.6.8.2	...	O.K.	Loose	Tighten screws, new paint protection film; new seat post as specified in parts list if damaged
Suntour suspension seat post	Every 100 hours or once a year	Complete clean, check fastening and paint protection film, lubricate	Section 8.6.8.3	...	O.K.	Loose	Tighten screws, new paint protection film; new seat post as specified in parts list if damaged
eightpins NGS2 Suspension seat post	20 hours	Refill oil	...	Section 7.4.19	O.K.	No oil	Refill oil
	20 hours	Clean wiper	...		O.K.	Dirt	Cleaning
	40 hours	Cleaning the slide bushing	...		O.K.	Dirt	Cleaning
	100 hours	Replace slide bushing, wiper and felt strip	...		O.K.	No replacement	Replace
	200 hours	Seal service for gas pressure spring	...		O.K.	No service	Carry out the service
eightpins H01 Suspension seat post	20 hours	Refill oil	...	Section 7.4.19	O.K.	No oil	Refill oil
	20 hours	Clean wiper	...		O.K.	Dirt	Cleaning
	40 hours	Cleaning the slide bushing	...		O.K.	Dirt	Cleaning
	100 hours	Replace slide bushing, wiper and felt strip	...		O.K.	No replacement	Replace
	200 hours	Seal service for gas pressure spring	...		O.K.	No service	Carry out the service



Components	Fre- quency	Description			Criteria		Measures if rejected
		Inspection	Tests	Maintenance	Accept- ance	Rejection	
RockShox suspension seat post	50 hours	Venting	...	See manufac- turer	O.K.		
	50 hours	Cleaning	...	See manufac- turer	O.K.		
	200 hours	Venting	...	See manufac- turer	O.K.		
	200 hours	Complete mainte- nance	...	See manufac- turer	O.K.		
	400 hours	Complete mainte- nance	...	See manufac- turer	O.K.		
	600 hours	Complete mainte- nance	...	See manufac- turer	O.K.		
FOX suspen- sion seat post	Every 125 hours or once a year	Complete mainte- nance	See manufac- turer	At the manufac- turer FOX	
Safety guards							
Belt or chain guards	6 months	Attachment	Check mount fastening	...	O.K.	Loose	Retighten screws
Guard	6 months	Attachment	Check mount fastening	...	O.K.	Loose	Retighten screws
Motor cover	6 months	Attachment	Check mount fastening	...	O.K.	Loose	Retighten screws
Brake system							
Brake lever	6 months	Attachment	Check mount fastening	...	O.K.	Loose	Retighten screws
Brake fluid	6 months	Check fluid level	Depending on time of year	...	O.K.	Too little	Top up brake fluid; <i>take Pedelec out of service</i> if damaged; new brake hoses
Brake linings	6 months	Brake linings, brake discs and rims	Check for damage	...	O.K.	Damage detected	New brake linings, brake discs and rims
Back-pedal brake braking armature	6 months	Attachment	Check mount fastening	...	O.K.	Loose	Retighten screws
Brake system	6 months	Attachment	Check mount fastening	...	O.K.	Loose	Retighten screws
Lighting system							
Light cabling	6 months	Connections, correct wiring	Check	...	O.K.	Cable defec- tive, no light	New cabling
Rear light	6 months	Side light	Functional check	...	O.K.	No constant light	New rear light as specified in parts list; replace if necessary
Front light	6 months	Side light, daytime riding light	Functional check	...	O.K.	No constant light	New front light as specified in parts list; replace if necessary
Reflectors	6 months	All complete, state, fastening	Check	...	O.K.	Damaged or not all complete	New reflectors



Components	Fre- quency	Description			Criteria		Measures if rejected
		Inspection	Tests	Maintenance	Accept- ance	Rejection	
Drive/gear shift							
Chain/ cassette/ pinion/chain- ring	6 months	Check for damage	Check for damage	...	O.K.	Damage	Refasten if necessary or replace as speci- fied in parts list
Chain guard/ spoke guard	6 months	Check for damage	Check for damage	...	O.K.	Damage	Replace as specified in parts list
Bottom bracket axle/ crank	6 months	Check mount fastening	Check mount fastening	...	O.K.	Loose	Retighten screws
Pedals	6 months	Check mount fastening	Check mount fastening	...	O.K.	Loose	Retighten screws
Shifter	6 months	Check mount fastening	Check mount fastening	...	O.K.	Loose	Retighten screws
Shift cables	6 months	Check for damage	Check for damage	...	O.K.	Loose and defective	Adjust shift cables; new shift cables if necessary
Front derail- leur	6 months	Check for damage	Check for damage	...	O.K.	Gear shift diffi- cult or not possible	Adjust
Rear derail- leur	6 months	Check for damage	Check for damage	...	O.K.	Gear shift diffi- cult or not possible	Adjust
Electric drive							
On-board computer	6 months	Check for damage	Check for damage	...	O.K.	No screen, defective screen display	Restart, test battery, new software or new on-board computer, <i>decommissioning</i> ,
Electric drive control panel	6 months	Check drive for damage	Check drive for damage	...	O.K.	No response	Restart; contact control panel manu- facturer, new control panel
Tachometer	6 months	Calibration	Speed meas- urement	...	O.K.	Pedelec travel- ling 10 % too fast/slow	Take pedelec out of service until the source of the error is found
Cabling	6 months	Visual inspection	Visual inspec- tion	...	O.K.	Failure in system, damage, kinked cables	New cabling
Recharge- able battery	6 months	First examination	see Section Assembly	...	O.K.	Error message	Contact battery manu- facturer; <i>take out of service</i> , new battery
Battery mount	6 months	Firmly in position, lock, contacts	Check mount fastening	...	O.K.	Loose; lock doesn't close, no contacts	New battery mount
Motor	6 months	Visual inspection and mount	Check mount fastening	...	O.K.	Damage, loose	Refasten motor, contact motor manu- facturer, new motor; <i>take out of service</i>
Software	6 months	Check version	Check soft- ware version	...	In latest version	Not latest version	Import update



Components	Fre- quency	Description			Criteria		Measures if rejected
		Inspection	Tests	Maintenance	Accept- ance	Rejection	
Miscellaneous							
Pannier rack	before each ride	Stability	Section 7.1.5	...	O.K.	Loose	Firm
	Once a month	Dirt	...	Section 7.3.4	O.K.	Dirt	Cleaning
	6 months	Servicing	...	Section 7.4.3	O.K.	Untreated	Wax
	6 months	Check fastening and paint protection film	Section 8.5.2	...	O.K.	Loose	Tighten screws, new paint protection film
Kickstand	Once a month	Dirt	...	Section 7.3.4	O.K.	Dirt	Cleaning
	6 months	Servicing	...	Section 7.4.5	O.K.	Untreated	Wax
	6 months	Attachment	Section 7.5.15	...	O.K.	Loose	Retighten screws
	6 months	Stability	Section 7.5.15	...	O.K.	Tips over	Change kickstand height
Bell	before each ride	Sound	Functional check Section 7.1.10	...	O.K.	No ring, too quiet, missing	New bell as specified in the parts list
Attachments (optional)	6 months	Attachment	Check mount fastening	...	O.K.	Loose	Retighten screws

Technical inspection, checking safety, test ride

Components	Description		Criteria		Measures if rejected
	Assembly/inspection	Tests	Acceptance	Rejection	
Brake system	6 months	Functional check	O.K.	No full braking; braking distance too long	Locate defective part in brake system and correct
Gear shift under operating load	6 months	Functional check	O.K.	Problems when shifting gear	Readjust gear shift
Suspension components (fork, shock absorber, seat post)	6 months	Functional check	O.K.	Suspension too deep or no longer exists	Locate defective component and correct
Electric drive	6 months	Functional check	O.K.	Loose connection, problems when riding, accelerate	Locate defective part in electric drive and correct
Lighting system	6 months	Functional check	O.K.	No continuous light, not bright enough	Locate defective part in lighting system and correct
Test ride	6 months	Functional check	No strange noises	Strange noises	Locate source of noise and correct



8.5.1 Servicing the frame

- 1 Check frame for cracks, warping and damage to the paintwork.
- ⇒ If there are any cracks, warping or damage to the paintwork, remove the pedelec from service. New frame as specified in the parts list.

8.5.1.1 Servicing the carbon frame

You need to distinguish between scratches on the paintwork and impacts if the carbon frame paintwork is damaged.

- ▶ Ask customer what caused the damage.
- ▶ Examine damage with a magnifying glass to see if fibres are permanently damaged.

Damage to paintwork

- 1 Gently sand paintwork damage with 600-grit sandpaper.
- 2 Smooth edges.
- 3 Apply one or two coats of repair paint.

Damage from impact

There may be damage to the laminate beneath the paintwork in the case of impact damage. The frame may break even under light stress.

- 1 Take pedelec out of service.
- 2 Send frame to a fibre composite repair company or purchase new frame as specified in the parts list.

8.5.2 Checking the pannier rack

Scratches, cracks and breaks may appear on the pannier rack caused by the panniers and cargo boxes.

- 1 Examine pannier rack for scratches, cracks and breaks.
- ⇒ Replace damaged pannier racks.
- ⇒ If the paint protection film is missing or has worn away, affix a new paint protection film.

8.5.3 Servicing axle with quick release



Crash caused by unfastened quick release

A faulty or incorrectly installed quick release may become caught in the brake disc and block the wheel. This will cause a crash.

- ▶ Install the front wheel quick release lever on the opposite side to the brake disc.

Crash caused by faulty or incorrectly installed quick release

The brake disc becomes very hot during operation. Parts of the quick release may become damaged as a result. The quick release comes loose. This will cause a crash with injuries.

- ▶ The front wheel quick release lever and the brake disc must be situated on opposite sides.

Crash caused by incorrectly set clamping force

Excessively high clamping force will damage the quick release and cause it to lose its function.

Insufficient clamping force will cause a detrimental transmission of force. The suspension fork or the frame may break. This will cause a crash with serious injuries.

- ▶ Never fasten a quick release using a tool (e.g. hammer or pliers).
- ▶ Only use the clamping lever with the specified set clamping force.

- 1 Undo quick release.
- 2 Fasten quick release.
- 3 Check the position and clamping force of the quick release lever.



- ⇒ The quick release lever is flush with the lower housing.
- ⇒ You should be able to see slight impression on the palm of your hand when you close the quick release lever.



Figure 138: Adjusting the quick release clamping force

- 4 Use a 4 mm hexagon socket spanner to adjust the clamping lever clamping force if required.
- 5 Check the quick release lever position and clamping force again.

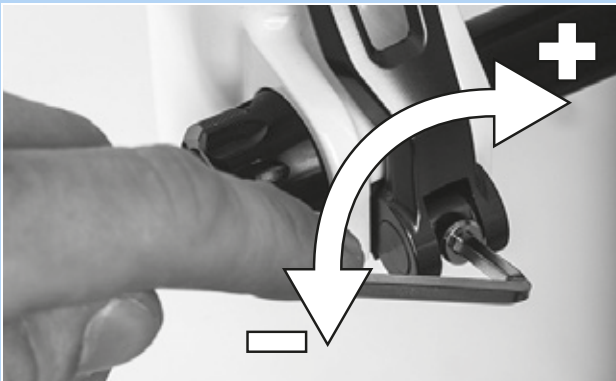

Figure 139: Adjusting the quick release clamping force

8.5.4 Maintaining the stem

Incorrectly fastened screws may come loose due to impact. The stem may no longer be firmly fixed in its position as a result. This will cause a crash with injuries.

- ▶ Check the handlebars and the stem's quick release are firmly in position.

8.5.5 Servicing the gear hub

8.5.5.1 Adjusting the hub with cone bearing

In the case of hubs with a cone bearing, the bearing shell fixed in the hub cone body rotates with its larger ball bearing surfaces around the inner bearing cone resting against the fork end. The outer bearing shell rotating around the stationary bearing cone is subject to considerably more evenly distributed loads thanks to its larger ball running surface.

- 1 Attach a small, red colour marking on the lock nut.
 - 2 Turn the wheel axle 40° to 90° every 1,000 to 2,000 km.
- ⇒ The bearing cone is subject to evenly distributed loads.



8.5.6 Servicing the steering headset

- 1 Remove fork.
- 2 Clean steering headset. If it is very dirty, flush the bearing with cleaning agents such as WD-40 or Karamba.
- 3 Check steering headset for damage.
 - ⇒ If the steering headset is damaged, replace steering headset as specified in the parts list.
- 4 Grease steering headset and bearing seat with highly viscous, water-repellent grease (e.g. Dura Ace special grease by SHIMANO).
- 5 Re-fit fork with steering headset as per fork instructions.

8.5.7 Servicing the fork

Only applies to pedelecs with this equipment

WARNING

Injury due to explosion

The air chamber is pressurised. If the air system in a faulty suspension fork is maintained, it can explode and cause serious injury.

- ▶ Wear safety goggles, protective gloves and safety clothing when assembling or carrying out maintenance on the bicycle.
- ▶ Release the air for the air chambers. Detach all air insert fitments.
- ▶ Never service or dismantle a suspension fork if it has not completely rebounded.

CAUTION

Hazard for the environment due to toxic substances

The suspension fork contains toxic and environmentally harmful oils and lubricants. Such fluids will contaminate if they enter the sewers or groundwater.

- ▶ Dispose of lubricants and oils left over after repairs in an environmentally responsible way in accordance with statutory regulations.

- 1 Remove fork.
- 2 Check fork for cracks, warping and damage to the paintwork.
 - ⇒ If there are any cracks, warping or damage to the paintwork, remove the pedelec from service. New fork as specified in the parts list.
- 3 Clean inside and exterior.
- 4 Grease fork.
- 5 Install fork.



8.5.7.1 Servicing the carbon suspension fork

- 1 Remove fork.
- 2 Check fork for cracks, warping and damage to the paintwork.
- 3 You need to distinguish between scratches on the paintwork and impacts if the carbon suspension fork paintwork is damaged.
 - ▶ Ask customer what caused the damage.
 - ▶ Examine damage with a magnifying glass to see if fibres are permanently damaged.

Damage to paintwork

- 1 Gently sand paintwork damage with 600-grit sandpaper.
- 2 Smooth edges.
- 3 Apply one or two coats of repair paint.

Damage from impact

There may be damage to the laminate beneath the paintwork in the case of impact damage. The fork may break even under light stress.

- ▶ Take pedelec out of service. New fork as specified in the parts list.
- ⇒ The fork must be free from any defects.
- 4 Clean inside and exterior.
 - 5 Grease fork.
 - 6 Install fork.

8.5.7.2 Servicing the suspension fork

- 1 Remove fork.
- 2 Check fork for cracks, warping and damage to the paintwork.
 - ⇒ If there are any cracks, warping or damage to the paintwork, remove the pedelec from service. New fork as specified in the parts list.
- 3 Dismantle suspension fork.
- 4 Lubricate dust seals and slide bushings.
- 5 Check torques.
- 6 Clean inside and exterior.
- 7 Grease fork.
- 8 Install fork.
- 9 Adjust suspension fork (see Section 6.3.14).



8.5.8 Servicing seat post



WARNING

Intoxication from lubrication oil

The lubrication oil for eightpins seat posts is toxic if touched or inhaled.

- ▶ Always wear safety goggles and nitrile gloves when working with lubrication oil.
- ▶ Lubricate seat post in the open air or in a well-ventilated room only.
- ▶ Avoid skin coming into contact with lubrication oil. Wear nitrile gloves when lubricating, cleaning and servicing the vehicle.
- ▶ Use an oil catchment tray under the section where the seat post is serviced.

- 1 Remove seat post from the frame.
- 2 Clean seat post on the inside and outside.
- 3 Examine seat post rack for scratches, cracks and breaks.
 - ⇒ Replaced damaged seat post as specified in the parts list.
 - ⇒ If the paint protection film is missing or has worn away, affix a new paint protection film.
- 4 Fit seat post as per height specifications in the pedelec pass.

8.5.8.1 Servicing the carbon seat post

Only applies to pedelecs with this equipment

You need to distinguish between scratches on the paintwork and impacts if the carbon seat post paintwork is damaged.

- ▶ Ask customer what caused the damage.
- ▶ Examine damage with a magnifying glass to see if fibres are permanently damaged.

Damage to paintwork

- 1 Gently sand paintwork damage with 600-grit sandpaper.
- 2 Smooth edges.
- 3 Apply one or two coats of repair paint.

Damage from impact

There may be damage to the laminate beneath the paintwork in the case of impact damage. The carbon seat post may break even under light stress.

- 1 Take pedelec out of service.
- 2 New carbon seat post as specified in the parts list.



8.5.8.2 by.schulz suspension seat post

Only applies to pedelecs with this equipment

- 1 Remove seat post from the frame.
 - 2 Remove safety and protective cover.
 - 3 Clean seat post on the inside and outside.
 - 4 Examine seat post rack for scratches, cracks and breaks.
- ⇒ Replaced damaged seat post as specified in the parts list.
- ⇒ If the paint protection film is missing or has worn away, affix a new paint protection film.
- 5 Lubricate screws in the parallel suspension.
 - 6 Reinsert seat post as per height specifications in the pedelec pass. Check screws for correct tightening torques.

□	Tightening torque G1 M8 seat clamping screw M5 fixing grub screws	20-24 Nm 3 Nm
---	--	------------------

□	Tightening torque G2 M6 seat clamping screw M5 fixing grub screws	12-14 Nm 3 Nm
---	--	------------------

- 7 Put on safety and protective cover.

8.5.8.3 Suntour suspension seat post

Only applies to pedelecs with this equipment

- 1 Remove seat post from the frame.
 - 2 Remove safety and protective cover.
 - 3 Examine seat post rack for scratches, cracks and breaks.
- ⇒ Replaced damaged seat post as specified in the parts list.
- ⇒ If the paint protection film is missing or has worn away, affix a new paint protection film.
- 4 Undo pre-tensioning adjuster and take out steel spring.
 - 5 Clean seat post on inside and outside.
 - 6 Grease seat post on inside with SR SUNTOUR no. 9170-001.
 - 7 Lubricate pressure roller with bike chain oil.
- ▶ Lubricate articulated joints in parallel suspension with bike chain oil.



Figure 140: SR Suntour suspension seat post lubrication points

- 8 Reinsert seat post as per height specifications in the pedelec pass.
- 9 Check screws for correct tightening torques.

□	Tightening torque Seat clamping screw M5 fixing grub screws	15-18 Nm 3 Nm
---	--	------------------

- 10 Put on safety and protective cover.



8.5.8.4 eightpins NGS2 seat post

Only applies to pedelecs with this equipment

Removing the seat post

- 1 Use a 2.5 mm hex key to turn the height adjustment 45° anti-clockwise and move to the “Open position”.



Figure 141: Moving height adjustment to the “Open position”

- 2 Activate operating lever. Pull seat post upwards at the same time and remove completely.



Figure 142: Pulling the seat post out

- 3 Activate operating lever. Hold Bowden cable fastener and pull or tilt forwards. Remove outer sleeve from the seat post remote control.



Figure 143: Removing the cartridge

- 4 Use a 5 mm to undo Postpin axle and pull out.



Figure 144: Undoing the Postpin axle

- 5 Pull cartridge from the piston rod while pushing the outer sleeve into the frame at the same time to help.

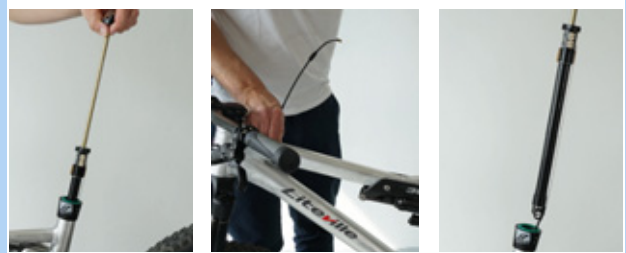

Figure 145: Pulling the cartridge out

- 6 Hold the cartridge with one hand at the height of the mechanism and pull the Bowden cable straight down with the other.
- 7 Hold the white actuating slide in the locking mechanism with your thumb.
- 8 Carefully push the Bowden cable upwards with the other hand and detach it.

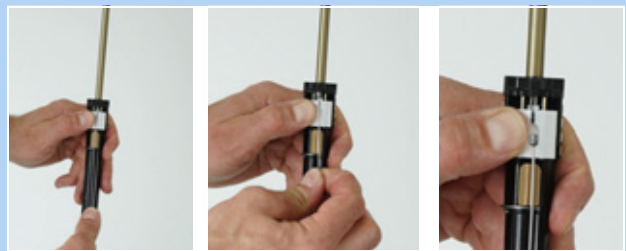

Figure 146: Detaching the Bowden cable

Notice

- ▶ Never pull Bowden cable forwards at an angle.

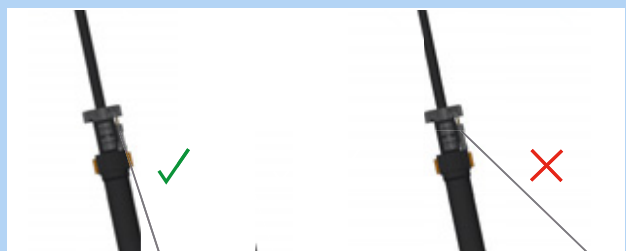

Figure 147: Bowden cable position



- 9 Pull out the outer sleeve end cap from the counter support on the Postpin interface on the seat post.

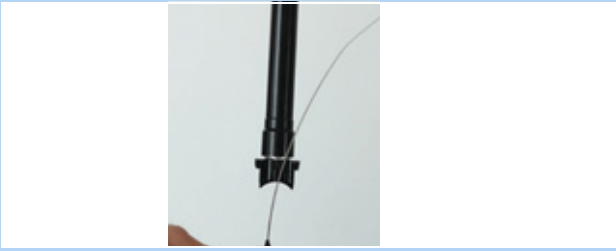

Figure 148: Pulling the end cap out

Removing the outer sleeve and slide bushing

- 1 Use a 3 mm hex spanner to remove attachment screw on the outer sleeve.
- 2 Detach outer sleeve by pulling upwards with your hand.
- 3 Pull slide bushing tube out of the seat tube.



Figure 149: Removing the outer sleeve and slide bushing

Caring for the outer sleeve

- 1 Detach spring washer or outer sealing ring.



Figure 150: Removed spring washer

- 2 Carefully remove the wiper from the groove.



Figure 151: Removing the wiper

- 3 Use a small, sharp object to look for and remove the end of the felt ring.
- 4 Carefully take out the felt ring.
- 5 Remove felt ring.
- 6 Clean or replace felt ring.



Figure 152: Removing the felt ring

- 7 Clean inside of outer sleeve with a cloth.

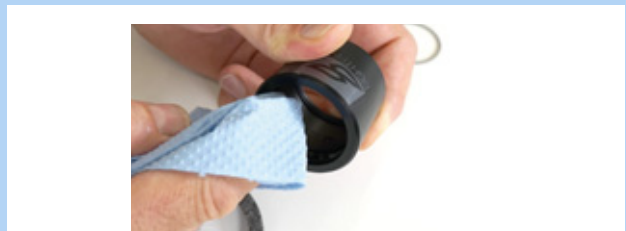

Figure 153: Cleaning the outer sleeve



- 8 Carefully re-insert dry felt ring with one end in the designated groove.
- 9 Unfurl felt ring within the outer sleeve, so that it lies on the groove.
- 10 Carefully press felt ring into the groove by hand. Ensure that both ends are fully pressed in and meet and that they do not overlap and are not twisted.



Figure 154: Inserting the felt ring

- 11 Insert cleaned or new wiper in the upper groove.
- 12 Stretch spring washer over the wiper.

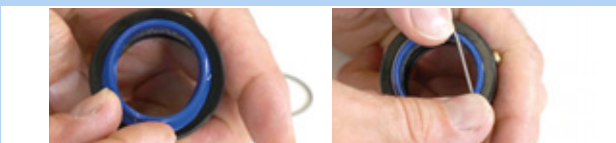

Figure 155: inserting and fastening the wiper

Cleaning the slide bushing

- 1 Clean the slide bushing tube with a damp cloth.

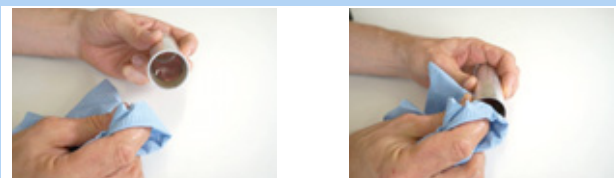

Figure 156: Cleaning the slide bushing tube

Notice

- ▶ Do not squash. The slide bushing tube wall is very thin.

Increasing the air pressure

- 1 Use 3 mm hex spanner to unscrew valve cap.



Figure 157: Unscrewing the valve cap

- 2 Screw valve adapter into mounting interface from below.



Figure 158: Screwing the valve adapter in

- 3 Use compression pump to pump the cartridge up to 24 bar.



Figure 159: Pumping the cartridge up

Notice

Screwing in the valve adapter will not open the valve. No pressure is displayed. The pressure is displayed when you start pumping.

- 4 Unscrew pump and valve adapter.



- 5 Use a 3 mm hex spanner to screw the valve lid back on and tighten with a maximum of 0.5 Nm.



Figure 160: Fastening the cartridge valve lid

Notice

- The cartridge is not airtight without the valve lid.

Setting the slipper clutch

- 1 Use 3 mm hex spanner to unscrew valve cap.

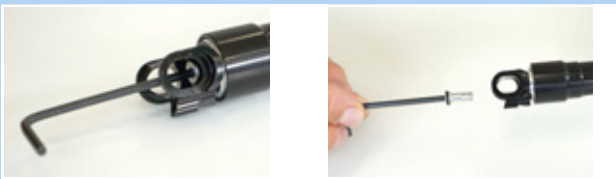

Figure 161: Unscrewing the valve cap

- 2 Secure the mounting interface against twisting with a 24 mm open-end spanner.



Figure 162: Securing against twisting

- 3 Set the torque to 18 Nm with a torque wrench and a 6 mm hex bit with a shaft length of at least 25 mm. Rotate clockwise.



Figure 163: Setting in a clockwise direction

- 4 Use a 3 mm hex spanner to screw the valve lid on and tighten with a maximum of 0.5 Nm.



Figure 164: Fastening the cartridge valve lid

Notice

- The cartridge is not airtight without the valve lid.



installing the outer sleeve and slide bushing

- 1 Carefully push slide bushing tube into the seat tube.
- 2 Press outer sleeve downwards with your hand.
- 3 Use a 3 mm hex spanner to fasten the attachment screw on the outer sleeve.



Figure 165: Fitting the slide bushing and outer sleeve

Fitting the seat post

- 1 Attach the outer sleeve end cap in the counterholder on the seat post frame interface.



Figure 166: Attaching the end cap

- 2 Use both thumbs to push white activation slider downwards and hold with one thumb.



Figure 167: Pushing the white activation slider downwards

- 3 Attach Bowden cable with the nipple to the bracket for the Bowden cable.



Figure 168: Correct and incorrect Bowden cable

Notice

- ▶ Never pull Bowden cable forwards at an angle.

- 4 Carefully push cartridge into the seat tube. Pull the Bowden cable out of the frame to help.



Figure 169: Fastening the cartridge valve lid

Notice

- ▶ Before continuing with installation, ensure that the Bowden cable is fed into the middle of the longitudinal guide. If the Bowden cable is off-centre, it will be pinched by the tube.

- 5 Look at the frame interface through the hole in the Postpin. Push the cartridge down until the Postpin mounting interface on the seat post reaches the Postpin interface on the frame.

- 6 If necessary, turn the seat post slightly and push it to the correct position so that the Postpin axle can be inserted.



Figure 170: Fastening the cartridge valve lid

- 7 Use a 5 mm hex spanner to screw in Postpin axle and fasten slightly.

- 8 Use torque spanner to tighten Postpin axle with 8 Nm.

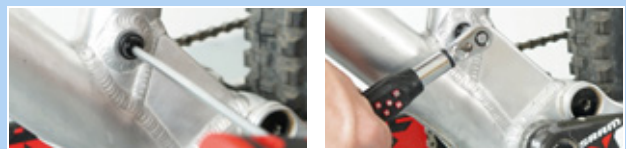

Figure 171: Fastening the Postpin axle



- 9** Carefully insert slide bushing tube into the seat tube.



Figure 172: Inserting the slide bushing tube into the seat tube

- 10** Place outer sleeve on the seat tube and push downwards firmly.



Figure 173: Attaching the outer sleeve

- 11** Turn the outer sleeve so that the outer sleeve mounting hole is aligned with the fastening hole in the frame.
- 12** Use a 3 mm hex spanner to fasten the M5 attachment screw into the outer sleeve.
- 13** Tighten screw gently with a maximum torque of 0.5 Nm.
- ⇒ The screw must easily screw into the outer sleeve without any resistance. If this is not the case, the hole in the frame is not aligned with the mounting hole in the outer sleeve. Turn outer sleeve into the right position.



Figure 174: Fastening the outer sleeve

- 14** Feed height adjustment clamp into the seat tube.

- ⇒ The two height adjustment clamp guides are in the longitudinal grooves inside the seat post.

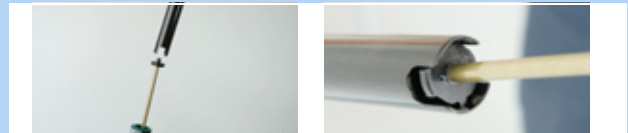

Figure 175: Feeding the height adjustment clamp in

- 15** Push the seat post carefully downwards and feed into the wiper.

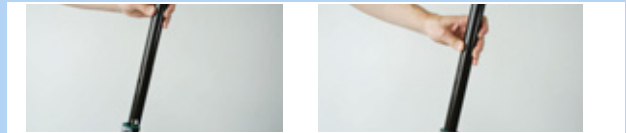

Figure 176: Pushing the seat post downwards

Notice

- ▶ Never let the seat post tube collide with the piston rod. There is a risk of scratches and damage to the piston rod. This will causes loss of air.

- 16** Move operating lever and press seat post downwards to the required height as per the values in the pedelec pass.



Figure 177: Setting the seat post height

- 17** Turn the height adjustment mechanism 45° in a clockwise direction and place in the "Closed position".



Figure 178: Closing the height adjustment



8.5.8.5 eightpins H01 seat post

Only applies to pedelecs with this equipment

Removing the seat post

- 1 Use a 5 mm hex spanner to unscrew the Postpin axle.

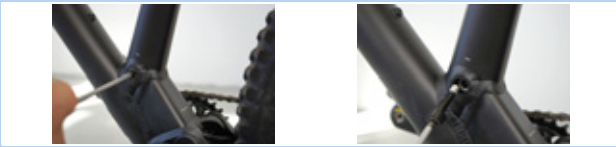

Figure 179: Undoing the seat post

- ▶ Detach Bowden cable from the on-bar remote control on the seat post.
- ▶ Detach the operating lever from the handlebars in the case of under-bar-remote control on the seat post. Activate operating lever. Hold Bowden cable fastener and pull or tilt forwards.

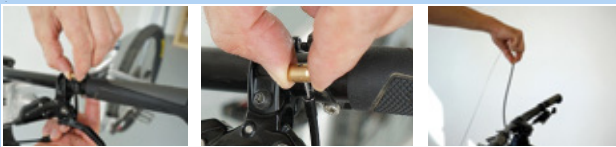

Figure 180: Unfastening the remote control

- 2 Pull seat post slowly out of the frame.

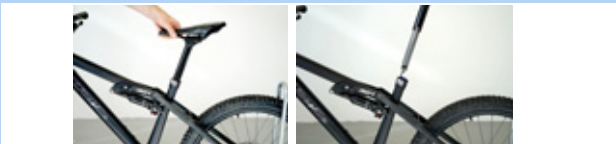

Figure 181: Removing the seat post

- 3 Pull out the special end cap for the outer sleeve from the bracket.
- 4 Detach the Bowden cable head from the hydraulic activation lever bracket.
- 5 If necessary, operate the lever by hand to make more space for detaching it.



Figure 182: Removing the Bowden cable

Removing the outer sleeve and slide bushing

- 1 Use a 3 mm hex spanner to remove attachment screw on the outer sleeve.
- 2 Detach outer sleeve by pulling upwards with your hand.
- 3 Pull slide bushing tube out of the seat tube.



Figure 183: Removing the outer sleeve and slide bushing

Caring for the outer sleeve

- 1 Push the blue wiper towards the edge.
- 2 Detach the seal lip ring.



Figure 184: Detaching the seal lip ring

- 3 Detach spring washer or outer sealing ring.



Figure 185: Removed spring washer



- 4** Carefully remove the wiper from the groove.



Figure 186: Removing the wiper

- 5** Use a small, sharp object to look for and remove the end of the felt ring.
- 6** Carefully take out the felt ring.
- 7** Remove felt ring.
- 8** Clean or replace felt ring.



Figure 187: Removing the felt ring

- 9** Clean inside of outer sleeve with a cloth.

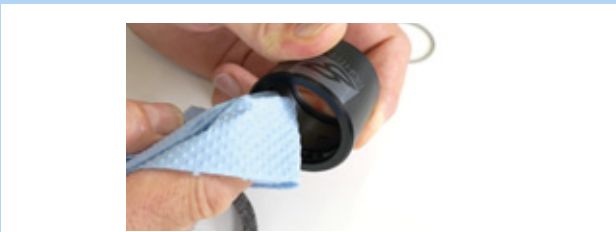

Figure 188: Cleaning the outer sleeve

- 10** Carefully re-insert dry felt ring with one end in the designated groove.
- 11** Unfurl felt ring within the outer sleeve, so that it lies on the groove.
- 12** Carefully press felt ring into the groove by hand. Ensure that both ends are fully pressed in and meet and that they do not overlap and are not twisted.



Figure 189: Inserting the felt ring

- 13** Insert cleaned or new wiper in the upper groove.

- 14** Stretch spring washer over the wiper.

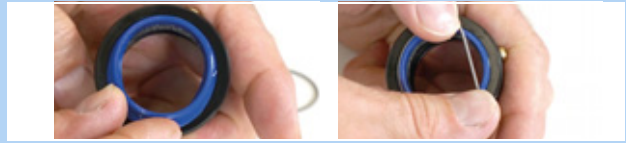

Figure 190: inserting and fastening the wiper



Clean slide bushing

- 1 Clean the slide bushing tube with a damp cloth.

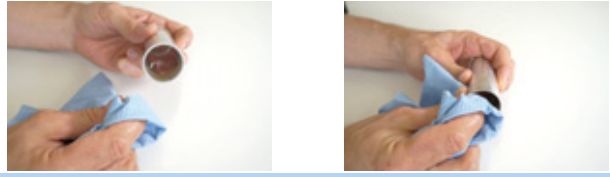

Figure 191: Cleaning the slide bushing tube

Notice

- ▶ Do not squash. The slide bushing tube wall is very thin.

Cleaning and lubricating the guide grooves

- 1 Push the operating lever forwards.



Figure 192: Opening the height adjustment

- 2 Pull seat post out with your hand until it will go no further.

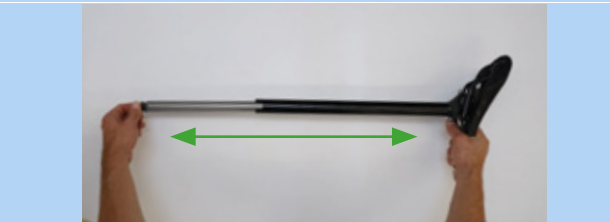

Figure 193: Pulling the seat post out

- 3 Clean the seat post longitudinal grooves with a damp cloth.



Figure 194: Cleaning the longitudinal groove

- 4 Apply grease into the longitudinal groove and on both cross-pieces.



Figure 195: Applying grease

- 5 Push seat post together.

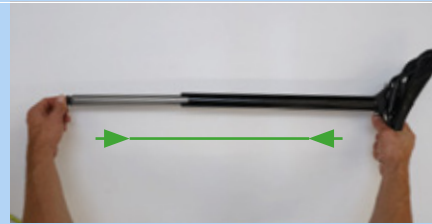

Figure 196: Pushing the seat post together

- 6 Push the height adjustment operating lever backwards.



Figure 197: Closing the height adjustment



installing the outer sleeve and slide bushing

- 1 Carefully push slide bushing tube into the seat tube.
- 2 Press outer sleeve downwards with your hand.
- 3 Use a 3 mm hex spanner to fasten the attachment screw on the outer sleeve.



Figure 198: Fitting the slide bushing and outer sleeve

Fitting the seat post

- 1 Attach Bowden cable head to the hydraulic activation lever bracket.
- 2 Push special end cap for the outer sleeve into the holder on the mounting interface.
- 3 Carefully push the seat post into the frame. In doing so, ensure that the wiper and the slide bushing do not become damaged.



Figure 199: Attaching and pushing in the seat post

- 4 Hold the Bowden cable firmly on the handlebars while feeding it in. Carefully pull the end of the Bowden cable from the frame so that the seat post slides downwards unhindered.



Figure 200: Attaching the end cap

- 5 Look at the frame interface through the hole in the Postpin. Push the seat post down until the Postpin mounting interface on the seat post reaches the Postpin interface on the frame.



Figure 201: Hole in the Postpin interface

- 6 If necessary, turn the seat post slightly and push it to the correct position so that the Postpin axle can be inserted.
- 7 Use a 5 mm hex spanner to screw in Postpin axle and fasten slightly.
- 8 Straighten saddle.
- 9 Use torque spanner to tighten Postpin axle with 8 Nm.

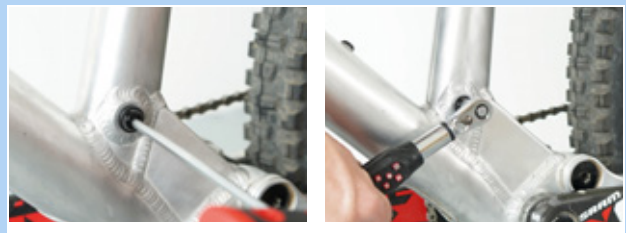

Figure 202: Screwing the seat post into position



8.5.9 Rear frame damper

Only applies to pedelecs with this equipment

WARNING

Injury due to explosion

The air chamber is pressurised. If the air system is serviced in a rear frame damper, it can explode and cause serious injury.

- ▶ Wear safety goggles, protective gloves and safety clothing when assembling or carrying out maintenance on the bicycle.
- ▶ Release the air for the air chambers. Detach all air insert fitments.
- ▶ Never service or dismantle a rear frame damper if it has not completely rebounded.

Intoxication from suspension oil

Suspension oil is poisonous to the touch, irritates respiratory tracts and causes cancer, sterility and mutation in germ cells.

- ▶ Always wear safety goggles and nitrile gloves when carrying suspension oil.
- ▶ Never perform maintenance when you are pregnant.
- ▶ Use an oil catchment tray under the section where the rear frame damper is being serviced.

Intoxication from lubrication oil

The lubrication oil for eightpins seat posts is toxic if touched or inhaled.

- ▶ Always wear safety goggles and nitrile gloves when working with lubrication oil.
- ▶ Lubricate seat post in the open air or in a well-ventilated room only.
- ▶ Avoid skin coming into contact with lubrication oil. Wear nitrile gloves when lubricating, cleaning and servicing the vehicle.
- ▶ Use an oil catchment tray under the section where the seat post is serviced.

CAUTION

Hazard for the environment due to toxic substances

The rear frame damper contains toxic and environmentally harmful oils and lubricants. Such fluids will contaminate if they enter the sewers or groundwater.

- ▶ Dispose of lubricants and oils left over after repairs in an environmentally responsible way in accordance with statutory regulations.

- 1 Dismantle the rear frame damper.
- 2 Clean and inspect its interior and exterior.
- 3 Recondition air springs.
- 4 Replace airtight seals on air springs.
- 5 Change oil.
- 6 Replace dust wipers.



8.5.9.1 FOX component-specific maintenance

FOX Service must perform maintenance on suspension forks, rear frame dampers and suspension seat posts.

- ▶ Maintenance includes a complete inspection of interiors/exterior.
- ▶ All dampers are reconditioned.
- ▶ The airtight seals are replaced in air suspension forks.
- ▶ The air spring is reconditioned.
- ▶ The oil is changed.
- ▶ The dust wipers are replaced.

More information at:

www.foxracingshox.de/service

9 Troubleshooting, fault clearance and repair

9.1 Troubleshooting and fault clearance

15 Contact your specialist dealer if the drive system won't start.

The control panel indicates whether a critical or less critical error has arisen in the drive system.

The error messages generated by the drive system can be read in the eBike Flow app and by the specialist dealer.

The rider can use a link in the eBike Flow app to display all information on errors and assistance on eliminating errors.

9.1.1 Drive system or on-board computer does not start up

If the on-board computer and/or the drive system do not start up, proceed as follows:

- 1 Check whether the battery is switched on. If not, start the battery.
- ⇒ Contact your specialist dealer if the battery level indicator LEDs do not light up.
- 2 If the LEDs on the Battery Level indicator light up, but the drive system does not start, remove the battery.
- 3 Insert the battery.
- 4 Start the drive system.
- 5 If the drive system does not start up, remove the battery.
- 6 Clean all the contacts with a soft cloth.
- 7 Insert the battery.
- 8 Start the drive system.
- 9 If the drive system does not start up, remove the battery.
- 10 Fully charge the battery.
- 11 Insert the battery.
- 12 Start the drive system.
- 13 If the drive system does not start, press the **On-Off button (control panel)** for at least 8 seconds.
- 14 If the drive system does not start after about 6 seconds, press the **On-Off button (control panel)** for at least 2 seconds.

9.1.2 Errors in assistance function

Symptom	Cause	Remedy
Assistance is not available.	Is the battery charged sufficiently?	<ol style="list-style-type: none"> 1 Check battery is charged. 2 Recharge the battery if it is almost flat.
	Is the system switched on?	<ul style="list-style-type: none"> ▶ Press On-Off button (battery). ⇨ The drive system starts.
	Is the level of assistance set to [OFF]?	<ol style="list-style-type: none"> 1 Set the assistance mode to a different level of assistance than [OFF]. 2 Contact your specialist dealer if you still feel that the no assistance is being supplied.
	The rechargeable battery, on-board computer or assistance switch may be connected incorrectly, or one or more of them may have a problem.	<ul style="list-style-type: none"> ▶ Contact specialist dealer.
	Are the pedals being pushed?	The pedelec is not a motorbike. <ul style="list-style-type: none"> ▶ Push the pedals.
	Is the speed too high?	The electronic gear assistance is only active up to a maximum speed of 25 km/h. <ul style="list-style-type: none"> ▶ Check on-board computer indicators.
	Is the lock function activated?	<ul style="list-style-type: none"> ▶ Use suitable on-board computer.
	The battery may become too hot during rides at high temperatures, up long inclines or when carrying a heavy load for a long time.	<ol style="list-style-type: none"> 1 Switch off the drive system. 2 Leave pedelec to cool down. 3 Start the drive system.
The assisted journey distance is too short.	Is the battery fully charged?	<ol style="list-style-type: none"> 1 Check charge level. 2 Recharge the battery if it is almost flat.
	The battery does not perform as well in winter weather.	This does not indicate a problem.
	The journey distance can be shorter depending on the road conditions, the gear level and the entire light usage time.	This does not indicate a problem.
	The battery is a consumable. Repeated charging and long periods of use cause the battery to degrade (loss of power).	If the distance covered with a fully charged battery has become shorter, the battery may be affected. <ul style="list-style-type: none"> ▶ Replace old battery with new one.
It is difficult to pedal.	Are the tyres pumped to an adequate pressure?	<ol style="list-style-type: none"> 1 Pump up tyres.
	Is the level of assistance set to [OFF]?	<ol style="list-style-type: none"> 1 Set level of assistance to [HIGH], [STD], [ECO] or [AUTO]. 2 Contact your specialist dealer if the pedals are still stiff.
	Is the battery fully charged?	<ol style="list-style-type: none"> 1 Check charge level. 2 Recharge the battery if it is almost flat.
	Have you switched on the system with your foot on the pedal?	<ol style="list-style-type: none"> 1 Switch system on again without applying pressure to the pedal. 2 Contact your specialist dealer if the pedals are still stiff.

Table 47: Error solution for assistance system

9.1.3 Battery errors

Symptom	Cause	Remedy
The battery discharges very quickly.	The battery may be at the end of its useful life.	► Replace old battery with new one.
The battery cannot be recharged.	Is the charger mains plug firmly connected to the socket?	<ol style="list-style-type: none"> 1 Disconnect the charger mains plug and plug it in again. 2 Start charging. 3 If the battery still won't recharge, contact your specialist dealer.
	Is the charger plug firmly connected to battery?	<ol style="list-style-type: none"> 1 Disconnect the charger plug and plug it in again. 2 Start charging. 3 If the battery still won't recharge, contact your specialist dealer.
	Is the adapter firmly connected to the charger plug or the battery's charging port?	<ol style="list-style-type: none"> 1 Connect the adapter firmly to the charger plug or the battery charging port. 2 Start charging. 3 If the battery still won't recharge, contact your specialist dealer.
	Is the connection terminal for the charger, charger adapter or batteries dirty?	<ol style="list-style-type: none"> 1 Wipe with a dry cloth to clean the connection terminals. 2 Start charging. 3 If the battery still won't recharge, contact your specialist dealer.
The battery does not start charging when the charger is connected.	The battery may be at the end of its useful life.	► Replace old battery with new one.
The battery and charger become hot.	Has the battery or charger temperature exceeded the operating temperature range?	<ol style="list-style-type: none"> 1 Interrupt charging process. 2 Leave battery and charger to cool down. 3 Start charging. <p>⇒ If the battery becomes too hot to touch, there might be a problem with the battery.</p> <ol style="list-style-type: none"> 4 Contact specialist dealer.
The charger is hot.	If the charger is used continuously to charge batteries, it may become hot.	<ol style="list-style-type: none"> 1 Interrupt charging process. 2 Leave charger to cool down. 3 Start charging.
The LED on the charger does not light up.	The LED on the charger will go out when the battery is fully charged.	This is not a malfunction.
	Is the charger plug firmly connected to battery?	<ol style="list-style-type: none"> 1 Check connection for any contaminants. 2 Insert charger plug. 3 If the battery still won't recharge, contact your specialist dealer.
	Is the battery fully charged?	<ol style="list-style-type: none"> 1 Disconnect charger mains plug. 2 Insert mains plug again. 3 Start charging. 4 Contact your specialist dealer if the LED on the charger still doesn't light up.
The battery cannot be removed.		► Contact your specialist dealer.
The battery cannot be inserted.		► Contact specialist dealer.
Fluid is leaking from the battery.		► Observe all the warnings in Section 2 Safety.

Table 48: Error solution for battery

Symptom	Cause	Remedy
There is an unusual smell.		<ol style="list-style-type: none"> 1 Remove from the battery immediately. 2 Contact the fire service immediately. 3 Observe all the warnings in Section 2 Safety.
Fumes are emitted from the battery.		<ol style="list-style-type: none"> 1 Remove from the battery immediately. 2 Contact the fire service immediately. 3 Observe all the warnings in Section 2 Safety.

Table 48: Error solution for battery

9.1.4 Display screen errors

Symptom	Cause	Remedy
No data are shown on the display screen if you press the on-off button (battery) .	The battery charge level may be insufficient.	<ol style="list-style-type: none"> 1 Charge the battery. 2 Switch on the power.
	Is the power switched on?	▶ Press the On-Off button (battery) to switch the power on.
	Is the battery charged?	If the battery is fitted to the pedelec and is being charged, it cannot be switched on. ▶ Interrupt charging.
	Is the connector fitted to the power cable correctly?	<ol style="list-style-type: none"> 1 Check whether the connector is fitted to the power cable correctly. 2 If the connector is not fitted correctly, contact your specialist dealer.
	A component may be connected which the system is unable to recognise.	▶ Contact specialist dealer.
The gear level is not shown on the display screen.	The gear level is only shown if the electronic gear shift is used.	<ol style="list-style-type: none"> 1 Check that the power cable connector has not been disconnected. 2 If this is not the case, contact your specialist dealer.
The settings menu cannot be opened while you are pedalling.	The product is designed in such a way that the settings menu cannot be opened if the system detects that someone is riding the pedelec. This is not a malfunction.	<ol style="list-style-type: none"> 1 Stop the pedelec. 2 Change settings when stationary only.
The lock function cannot be set up or switched off.	It may be a firmware error.	▶ Contact specialist dealer.
The connect account has been deleted or deactivated and the lock function is still activated.	...	▶ Contact specialist dealer.

Table 49: On-board computer error solution

9.1.5 Lighting does not work

Symptom	Cause	Remedy
Front lamp or rear lamp does not go on, even when the switch is pressed.	The basic settings in the electric drive system have probably been configured incorrectly.	<ol style="list-style-type: none"> 1 Take pedelec out of service immediately. 2 Contact specialist dealer.
	The light is defective.	

Table 50: Lighting error solution

9.1.6 Other errors

Symptom	Cause	Remedy
Two beeps will sound if a switch is pressed but the switch cannot be operated.	Pressed switch mode has been deactivated.	▶ This is not a malfunction.
Three beeps are sounded.	A fault or warning has occurred.	▶ This occurs when a warning or an error is shown on the on-board computer. Follow the instructions for the code indicated on screen in Section 6.2 System Messages.
If an electronic gear shift is used, pedal assistance becomes weaker when the gear is changed.	This is because the computer sets the pedal assistance to the optimum level.	▶ This is not a malfunction.
A noise can be heard after switching.		▶ Contact your specialist dealer.
It is normal to hear a noise coming from the rear wheel when cycling as normal.	The gear shift setting may not have been made properly.	▶ Contact your specialist dealer.
If the pedelec is brought to a stop the pedelec, the gear transmission does not switch to the position pre-configured in the functional feature.	You may have applied too much pressure on the pedals.	▶ Press on the pedals only gently to make it easier to change the transmission.

Table 51: Other drive system errors

9.1.7 Suntour suspension fork

9.1.7.1 Rebound too fast

The suspension fork rebounds too quickly, producing a "pogo stick" effect, where the wheel lifts from the ground in an uncontrolled way. This impairs traction and control (blue line).

Fork head and handlebars are deflected upwards if the wheel bounces back from the ground. Body weight may be thrown up and back in an uncontrolled way (green line).

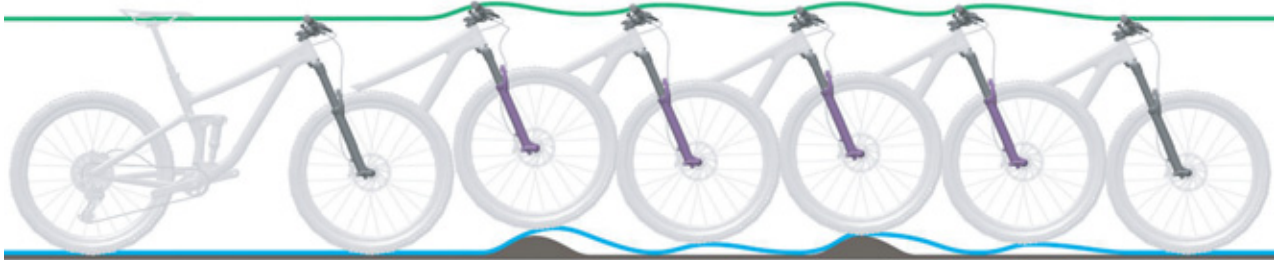

Figure 203: Suspension fork rebounding too quickly

Solution



Figure 204: Suntour rebound screw (1)

- ▶ Turn **rebound screw** in a clockwise direction.
- ⇒ The rebound speed is decreased (slower return).

9.1.7.2 Rebounding too slowly

The fork does not rebound quickly enough after absorbing a bump. The fork also remains deflected over subsequent bumps, which reduces deflection and increases the hardness of impacts. Available deflection, traction and control decrease (blue line).

The fork remains in a deflected state, causing the headset and handlebars to move to a lower position. Body weight is shifted forward after the impact (green line).

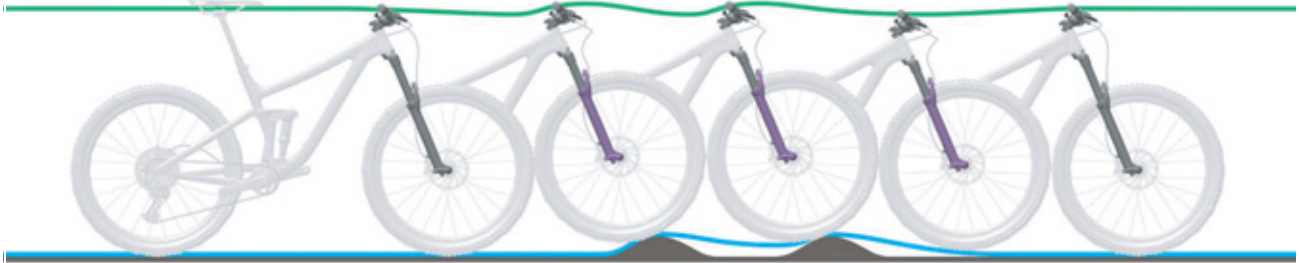

Figure 205: Suspension fork rebounding too slowly

Solution

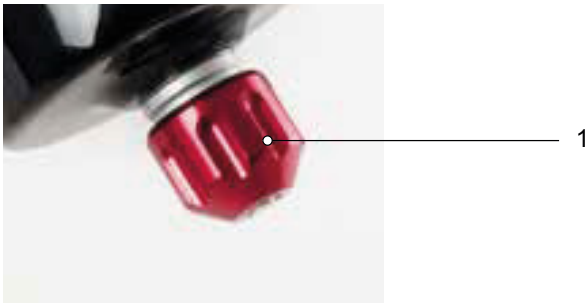

Figure 206: Suntour rebound screw (1)

- ▶ Turn **rebound screw** in an anti-clockwise direction.
- ⇒ The rebound speed is increased (faster return).

9.1.7.3 Suspension too soft on inclines

The fork deflects at a low point in the terrain. The deflection is quickly used up, body weight shifts forward and the pedelec loses some momentum.



Figure 207: Excessively soft suspension in the suspension fork on hilly terrain

Solution



Figure 208: Changing compression adjuster to a harder setting

- ▶ Turn **compression adjuster** in a clockwise direction towards **LOCK**.
- ⇒ The damping and compression hardness are increased and the deflection stroke speed. Efficiency on hilly and flat terrain is improved.

9.1.7.4 Excessively hard damping on bumps

When the bike hits a bump, the fork deflects too slowly and the wheel lifts up from the bump. Traction decreases when the wheel no longer touches the ground.

The headset and handlebars are deflected upwards significantly, which can impair control.

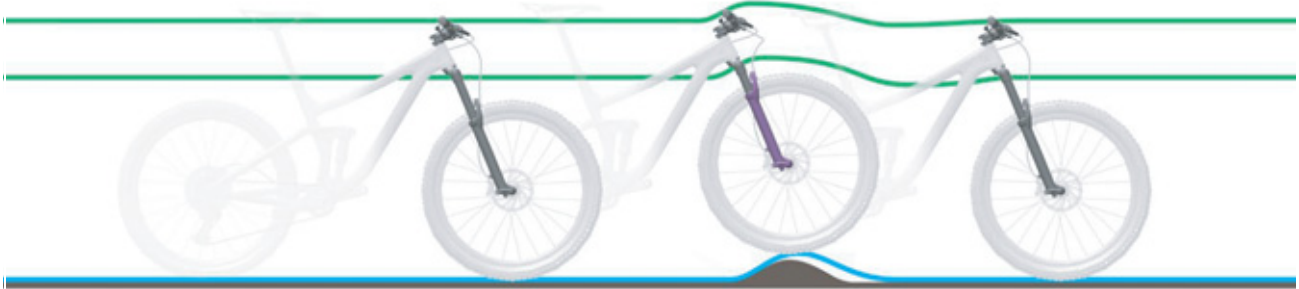

Figure 209: Excessively hard damping in the suspension fork on bumps

Solution

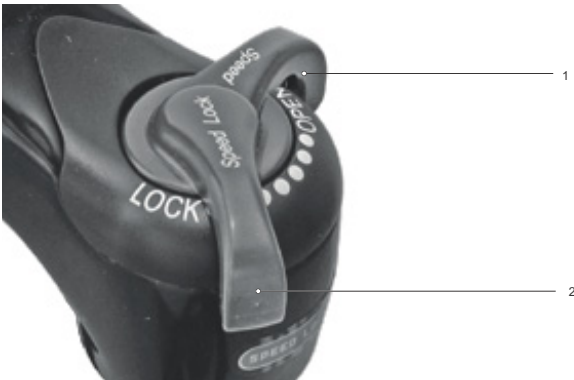

Figure 210: Changing compression adjuster to a softer setting

- ▶ Turn **compression adjuster** in a clockwise direction towards OPEN.
- ⇒ The damping and compression hardness reduces and the deflection stroke speed is reduced. Sensitivity to small bumps is increased.

9.1.8 Rear frame damper

9.1.8.1 Rebound too fast

The rear frame damper rebounds too quickly, producing a “pogo stick” effect or causing the bike to bounce after the wheel hits a bump and lands on the ground again. This impairs traction and control due to the uncontrolled speed at which the damper rebounds after deflecting (blue line).

Saddle and handlebars are deflected upwards when the wheel bounces back from the ground. The rider's body weight may be shifted upwards and forwards if the damper fully rebounds too quickly (green line).



Figure 211: Rear frame damper rebounding too quickly

Solution



Figure 212: Suntour rebound adjuster wheel (1) on the rear frame damper

- ▶ Turn **rebound wheel** towards plus.
- ⇒ The deflection movement is reduced.

9.1.8.2 Rebounding too slowly

The rear frame damper does not rebound quickly enough after a bump has been compensated and is not in the required initial position when the wheel hits the next bump. The rear frame damper remains compressed during successive bumps, thus reducing deflection and ground contact and increasing hardness on the next impact. The rear wheel bounces off the second bump since the rear frame damper does not rebound quickly enough to make contact with the ground and return to the initial position again. The available deflection and traction are reduced (blue line).

The rear frame damper remains in a deflected state after contact with the first bump. When the rear wheel hits the second bump, the saddle follows the path of the rear wheel instead of remaining in a horizontal position. The available deflection and potential absorption of bumps are reduced, which causes instability and loss of control during successive bumps (green line).



Figure 213: Rear frame damper rebounding too slowly

Solution



Figure 214: Suntour rebound adjuster wheel (1) on the rear frame damper

- ▶ Turn **rebound wheel** towards minus.
- ⇒ The rebound movement is increased.

9.1.8.3 Suspension too soft on inclines

The rear frame damper deflects deeply through the deflection range. Deflection is quickly used up,

the rider's weight shifts forward and the bicycle loses some momentum.



Figure 215: Excessively soft suspension in the rear frame damper on hilly terrain

Solution



Figure 216: Suntour compression adjuster (1) on the rear frame damper

- ▶ Turn **compression adjuster** clockwise.
- ⇒ The damping and compression hardness is increased and the deflection stroke speed is reduced. Efficiency on hilly and flat terrain is improved.

9.1.8.4 Excessively hard damping on bumps

When the bike hits a bump, the damper deflects too slowly and the rear wheel lifts up from the bump. Traction is reduced (blue line).

Saddle and rider are deflected upwards and forwards, the rear wheel loses contact with the ground and control is reduced (green line).



Figure 217: Excessively hard damping in the rear frame damper on bumps

Solution

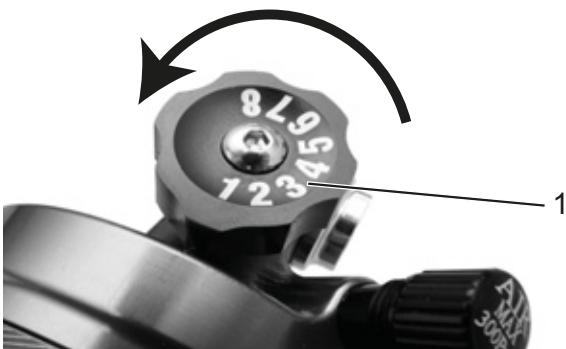

Figure 218: Suntour compression adjuster (1) on the rear frame damper

- ▶ Turn **compression adjuster** anti-clockwise.
- ⇒ The damping and compression hardness is reduced and the deflection stroke speed is increased. Sensitivity to small bumps is increased.

9.2 Repair

Special expertise and tools are required for many repairs. For this reason, repairs may only be carried out at a specialist dealer. These include:

- Replacing tyres and rims
- Replacing rims, brake linings and brake discs
- Replacing and tensioning the chain.

9.2.1 Original parts and lubricants

The individual pedelec parts have been carefully selected and matched to one other.

Only original parts and lubricants must be used for maintenance and repair.

The constantly updated accessory approval and parts lists are in Section 11, Documents and Drawings.

- ▶ Follow the operating instructions for the new components.

9.2.2 Replacing the lighting

- ▶ Only use components of the respective power class for replacement.

9.2.3 Setting the front light

- ▶ The *front light* must be set so that its light beam shines on the road 10 m in front of the pedelec.

9.2.4 Checking tyre clearance

The tyre needs to be checked each time a suspension fork tyre is changed to another size.

- 1 Release pressure from the fork.
- 2 Press fork together fully.
- 3 Measure the gap between the top of the tyre and the crown's lower surface. The gap must not be less than 10 mm. If the tyre is too large, the tyre will touch the crown's lower surface if the fork is fully pressed together.
- 4 Release pressure on fork and pump it up again if it is an air suspension fork.
- 5 Take into account the fact that the gap will be smaller if there is a guard. Check again to ensure that there is sufficient clearance for the tyre.

9.2.5 Replacing pedelec components if lock function is installed

9.2.5.1 Replacing a smartphone

- 1 Install Bosch eBike connect app on the new smartphone.
 - 2 Log on using the same account which was used to activate the lock function.
 - 3 Connect on-board computer with the smartphone while the on-board computer is in use.
- ⇒ The lock function is shown as set up in the BOSCH eBike Connect app.

9.2.5.2 Replacing the on-board computer

- Connect on-board computer with the smartphone while the on-board computer is in use.
- ⇒ The lock function is shown as set up in the BOSCH eBike Connect app.

9.2.5.3 Activating the lock function after motor replacement

- ✓ The lock function is displayed as deactivated in the eBike Connect app when the motor has been replaced.
- 1 Open the <My eBike> menu item in the eBike Connect app.
 - 2 Push the <Lock function> slider to the right.
- ⇒ The drive unit assistance can now be deactivated by removing the on-board computer.

10 Recycling and disposal



This device is marked according to the European Directive 2012/19/EU on waste electrical and electronic equipment – WEEE and the European



Directive 2006/66/EC on accumulators. The directive provides the framework for the return and recycling of used devices

across the EU. Consumers are legally required to return all used batteries of any type. It is forbidden to dispose of batteries in domestic waste.

The battery manufacturer is legally obliged to take back used and old batteries free of charge according to Section 9 German Batteries Act. The pedelec frame, battery, motor, on-board computer and charger are recyclable materials. You must dispose of and recycle them separately from the domestic waste in compliance with applicable statutory regulations. Separate collection and

recycling saves reserves of raw materials and ensures that all the regulations for protection of health and the environment are adhered to when recycling the product and/or the battery.

- ▶ Never dismantle the pedelec, battery or charger for disposal.

The pedelec, on-board computer, the unopened and undamaged battery and the charger can be returned to any specialist dealer free of charge. Further disposal options may be available, depending on the region.

- ▶ Store the individual parts of the decommissioned pedelec in a dry place, free from frost, where they are protected from direct sunlight.

10.1 Removal of waste guidelines

Waste type	Disposal
Non-hazardous waste	
Recycling	
Waste paper, cardboard	Return paper collection bin, paper container, undamaged transport packaging to suppliers
Scrap metal and aluminium	Take to municipal collection points or have collected by waste disposal companies
Tyres, tubes	Tyre manufacturers' collection points, collection forms and fax templates available from tyre manufacturers Otherwise, residual waste bin (grey bin)
Fibre composite components (e.g. carbon, GRP)	Large carbon components such as defective frames and carbon rims can be sent to special collection points for recycling; see www.cfk-recycling.de/index.php?id=57
Dual system sales packaging made of plastic, metal and composite material, lightweight packaging	Collection by waste disposal firm where applicable; return transport packaging to suppliers Plastic waste bin (yellow bin)
CDs, DVDs	Take to municipal collection points since they are made of high-grade plastic and are easy to recycle Otherwise, residual waste bin (grey bin)

Table 52: Removal of waste guidelines

Waste type	Disposal
Dispose of	
Residual waste	Residual waste bin (grey bin)
Biodegradable lubricants Biodegradable oils Biodegradable cleaning cloths daubed in oil	Residual waste bin (grey bin)
Filament lamps, halogen lamps	Residual waste bin (grey bin)
Hazardous waste	
 Recycling	
Batteries, rechargeable batteries	Return to the battery manufacturer
Electric devices: Motor Display Control panel Wiring	Take to a municipal collection point for electronic waste
Dispose of	
Waste oil Cleaning cloths daubed in oil Lubrication oil Gear oil Lubricating grease Cleaning fluids Kerosene White spirit Hydraulic fluid Brake fluid	<p>Never mix different oil fluids. Store in original container</p> <p>Small quantities (usually <30 kg) Take to municipal collection points for hazardous waste (e.g. mobile toxic waste collection service)</p> <p>Larger quantities (>30 kg) Collection by waste disposal companies</p>
Paints Varnishes Thinners	Take to municipal collection points for hazardous waste (e.g. mobile toxic waste collection service)
Neon lights, energy-saving lamps	Take to municipal collection points for hazardous waste (e.g. mobile toxic waste collection service)

Table 52: Removal of waste guidelines



11 Documents

11.1 Assembly report

Date:

Frame number:

Components	Description	Tests	Criteria		Measures if rejected
			Acceptance	Rejection	
Front wheel	Assembly		O.K.	Loose	Adjust quick release
Kickstand	Check mount fastening	Functional check	O.K.	Loose	Retighten screws
Tyres		Tyre pressure check	O.K.	Tyre pressure too low/ too high	Adjust tyre pressure
Frame	Check for damage – fracture, scratches		O.K.	Damage detected	<i>Take out of operation</i> , new frame
Handles, coverings	Check mount fastening		O.K.	Not provided	Retighten screws, new handles and coverings as specified in parts list
Handlebars, stem	Check mount fastening		O.K.	Loose	Retighten screws; new stem as specified in parts list if necessary
Steering headset	Check for damage	Functional check	O.K.	Loose	Retighten screws
Saddle	Check mount fastening		O.K.	Loose	Retighten screws
Seat post	Check mount fastening		O.K.	Loose	Retighten screws
Guard	Check mount fastening		O.K.	Loose	Retighten screws
Pannier rack	Check mount fastening		O.K.	Loose	Retighten screws
Attachments	Check mount fastening		O.K.	Loose	Retighten screws
Bell		Functional check	O.K.	No ring, too quiet, missing	New bell as specified in the parts list
Suspension elements					
Fork, suspension fork	Check for damage		O.K.	Damage detected	New fork as specified in the parts list
Rear frame damper	Check for damage		O.K.	Damage detected	New fork as specified in the parts list
Suspension seat post	Check for damage		O.K.	Damage detected	New fork as specified in the parts list
Brake system					
Brake lever	Check mount fastening		O.K.	Loose	Retighten screws
Brake fluid	Check fluid level		O.K.	Too little	Refill with brake fluid; new brake hoses if damaged
Brake linings	Check brake linings, brake discs and rims for damage		O.K.	Damage detected	New brake linings, brake discs and rims
Back-pedal brake braking armature	Check mount fastening		O.K.	Loose	Retighten screws
Lighting system					
Rechargeable battery	First examination		O.K.	Error message	<i>Take out of service</i> ; contact battery manufacturer, new battery
Light cabling	Connections, correct wiring		O.K.	Cable defective, no light	New cabling
Rear light	Side light	Functional check	O.K.	No constant light	<i>Take out of service</i> ; new rear light as specified in parts list; replace if necessary
Front light	Side light, daytime riding light	Functional check	O.K.	No constant light	<i>Take out of service</i> ; new front light as specified in parts list; replace if necessary
Reflectors	All complete, state, fastening		O.K.	Damaged or not all complete	New reflectors



Drive/gear shift					
Chain/cassette/pinion/chaining	Check for damage		O.K.	Damage	Refasten if necessary or replace as specified in parts list
Chain guard/spoke guard	Check for damage		O.K.	Damage	Replace as specified in parts list
Bottom bracket axle/crank	Check mount fastening		O.K.	Loose	Retighten screws
Pedals	Check mount fastening		O.K.	Loose	Retighten screws
Shifter	Check mount fastening	Functional check	O.K.	Loose	Retighten screws
Shift cables	Check for damage	Functional check	O.K.	Loose and defective	Adjust shift cables; new shift cables if necessary
Front derailleur	Check for damage	Functional check	O.K.	Switching gears difficult or not possible	Adjust
Rear derailleur	Check for damage	Functional check	O.K.	Switching gears difficult or not possible	Adjust
Electric drive					
On-board computer	Check for damage	Functional check	O.K.	No screen, defective screen display	Restart, test battery, new software or new on-board computer, <i>take out of service</i>
Electric drive control panel	Drive Check for damage	Functional check	O.K.	No response	Restart; contact control panel manufacturer, new control panel
Tachometer		Speed measurement	O.K.	Pedelec travelling 10 % too fast/slow	Take pedelec out of service until the source of the error is found
Cabling	Visual inspection		O.K.	Failure in system, damage, kinked cables	New cabling
Battery mount	Firmly in position, lock, contacts	Functional check	O.K.	Loose; lock doesn't close, no contacts	New battery mount
Motor	Visual inspection and mount		O.K.	Damage, loose	Refasten motor, contact motor manufacturer, new motor
Software	Check version		In latest version	Not latest version	Import update

Technical inspection, checking safety, test ride

Components	Description		Criteria		Measures if rejected
	Assembly/inspection	Tests	Acceptance	Rejection	
Brake system		Functional check	O.K.	No full braking; braking distance too long	Locate defective part in brake system and correct
Gear shift under operating load		Functional check	O.K.	Problems when shifting gear	Readjust gear shift
Suspension components (fork, shock absorber, seat post)		Functional check	O.K.	Suspension too deep or no longer exists	Locate defective component and correct
Electric drive		Functional check	O.K.	Loose connection, problems when riding, accelerate	Locate defective part in electric drive and correct
Lighting system		Functional check	O.K.	No continuous light, not bright enough	Locate defective part in lighting system and correct
Test ride			No strange noises	Strange noises	Locate source of noise and correct

Date:	
Fitter's name:	
Final inspection by workshop manager	



11.2 Maintenance log

Diagnosis and documentation of current status

Date:

Frame number:

Components	Frequency	Description			Criteria		Measures if rejected
		Inspection	Tests	Maintenance	Acceptance	Rejection	
Front wheel	6 months	Assembly			O.K.	Loose	Adjust quick release
Kickstand	6 months	Check mount fastening	Functional check		O.K.	Loose	Retighten screws
Tyres	6 months		Tyre pressure check		O.K.	Tyre pressure too low/ too high	Adjust tyre pressure
Frame	6 months	Check for damage – fracture, scratches			O.K.	Damage detected	Take pedelec out of service, new frame
Handles, coverings	6 months	Wear; check if fastened securely			O.K.	Not provided	Retighten screws, new handles and coverings as specified in parts list
Handlebars, stem	6 months	Check mount fastening			O.K.	Loose	Retighten screws; new stem as specified in parts list if necessary
Steering headset	6 months	Check for damage	Functional check	Lubricating and adjustment	O.K.	Loose	Retighten screws
Saddle	6 months	Check mount fastening			O.K.	Loose	Retighten screws
Seat post	6 months	Check mount fastening			O.K.	Loose	Retighten screws
Guard	6 months	Check mount fastening			O.K.	Loose	Retighten screws
Pannier rack	6 months	Check mount fastening			O.K.	Loose	Retighten screws
Attachments	6 months	Check mount fastening			O.K.	Loose	Retighten screws
Bell	6 months		Functional check		O.K.	No ring, too quiet, missing	New bell as specified in the parts list
Suspension elements							
Fork, suspension fork	To manufacturer's specifications*	Check for damage, corrosion, fracture		Maintenance as specified by manufacturer Lubrication, oil change as specified by manufacturer	O.K.	Damage detected	New fork as specified in the parts list
Rear frame damper	To manufacturer's specifications*	Check for damage, corrosion, fracture		Maintenance as specified by manufacturer Lubrication, oil change as specified by manufacturer	O.K.	Damage detected	New fork as specified in the parts list
Suspension seat post	To manufacturer's specifications*	Check for damage		Maintenance as specified by manufacturer	O.K.	Damage detected	New fork as specified in the parts list



Components	Frequency	Description			Criteria		Measures if rejected
		Inspection	Tests	Maintenance	Acceptance	Rejection	
Brake system							
Brake lever	6 months	Check mount fastening			O.K.	Loose	Retighten screws
Brake fluid	6 months	Check fluid level		Depending on time of year	O.K.	Too little	Top up brake fluid; <i>take Pedelec out of service</i> if damaged; new brake hoses
Brake linings	6 months	Check brake linings, brake discs and rims for damage			O.K.	Damage detected	New brake linings, brake discs and rims
Back-pedal brake braking armature	6 months	Check mount fastening			O.K.	Loose	Retighten screws
Brake system	6 months	Check mount fastening		Functional check	O.K.	Loose	Retighten screws
Lighting system							
Rechargeable battery	6 months	First examination			O.K.	Error message	Contact battery manufacturer; <i>take out of service</i> , new battery
Light cabling	6 months	Connections, correct wiring			O.K.	Cable defective, no light	New cabling
Rear light	6 months	Side light	Functional check		O.K.	No constant light	New rear light as specified in parts list; replace if necessary
Front lamp	6 months	Side light, daytime riding light	Functional check		O.K.	No constant light	New front light as specified in parts list; replace if necessary
Reflectors	6 months	All complete, state, fastening			O.K.	Damaged or not all complete	New reflectors
Drive/gear shift							
Chain/cassette/pinion/chainring	6 months	Check for damage			O.K.	Damage	Refasten if necessary or replace as specified in parts list
Chain guard/spoke guard	6 months	Check for damage			O.K.	Damage	Replace as specified in parts list
Bottom bracket axle/crank	6 months	Check mount fastening			O.K.	Loose	Retighten screws
Pedals	6 months	Check mount fastening			O.K.	Loose	Retighten screws
Shifter	6 months	Check mount fastening	Functional check		O.K.	Loose	Retighten screws
Shift cables	6 months	Check for damage	Functional check		O.K.	Loose and defective	Adjust shift cables; new shift cables if necessary
Front derailleur	6 months	Check for damage	Functional check		O.K.	Switching gears difficult or not possible	Adjust
Rear derailleur	6 months	Check for damage	Functional check		O.K.	Switching gears difficult or not possible	Adjust



Components	Frequency	Description			Criteria		Measures if rejected
		Inspection	Tests	Maintenance	Acceptance	Rejection	
Electric drive							
On-board computer	6 months	Check for damage	Functional check		O.K.	No screen, defective screen display	Restart, test battery, new software or new on-board computer; <i>take out of service</i>
Electric drive control panel	6 months	Drive Check for damage	Functional check		O.K.	No response	Restart; contact control panel manufacturer, new control panel
Tachometer	6 months		Speed measurement		O.K.	Pedelec travelling 10 % too fast/slow	Take pedelec out of service until the source of the error is found
Cabling	6 months	Visual inspection			O.K.	Failure in system, damage, kinked cables	New cabling
Battery mount	6 months	Firmly in position, lock, contacts	Functional check		O.K.	Loose; lock doesn't close, no contacts	New battery mount
Motor	6 months	Visual inspection and mount			O.K.	Damage, loose	Refasten motor; contact motor manufacturer, new motor; <i>take out of service</i>
Software	6 months	Check version			In latest version	Not latest version	Import update

Technical inspection, checking safety, test ride

Components	Description		Criteria		Measures if rejected
	Assembly/inspection	Tests	Acceptance	Rejection	
Brake system	6 months	Functional check	O.K.	No full braking; braking distance too long	Locate defective part in brake system and correct
Gear shift under operating load	6 months	Functional check	O.K.	Problems when shifting gear	Readjust gear shift
Suspension components (fork, shock absorber, seat post)	6 months	Functional check	O.K.	Suspension too deep or no longer exists	Locate defective component and correct
Electric drive	6 months	Functional check	O.K.	Loose connection, problems when riding, accelerate	Locate defective part in electric drive and correct
Lighting system	6 months	Functional check	O.K.	No continuous light, not bright enough	Locate defective part in lighting system and correct
Test ride	6 months	Functional check	No strange noises	Strange noises	Locate source of noise and correct

Date:	
Fitter's name:	
Final inspection by workshop manager	



Notes

11.3 Parts list

11.3.1 QUADRIGA COMP BELT CX5

KB185-xxFD, KB185-xxFW

Frame material	...	Aluminium
Fork	SR Suntour NCX-D, Air	Deflection: 63 mm
Steering headset	FSA, 55R	1.5 inch
Handlebars	COMPETITION, SL Trekking/ SL Ergo	Handlebar width: 640 mm /620 mm
Handles	ERGON, GP1/ GC10-Nexus	...
Stem	COMPETITION, SL, adjustable	...
Saddle	COMODORO, M / XL	...
Seat post	SATORI, Harmony LT2 suspension seatpost	34.9 mm
Saddle clamp	SATORI	38.6 mm
Crank set	SAMOX	Crank length: 170 mm
Pedals	ZECURE, VP-658	...
Rear derailleur
Shifter	SHIMANO, Nexus SL-C7000-5	...
Front derailleur
Cassette/cassette sprocket	GATES, Inter 5	32T
Chain
Toothed belt	GATES, CDX	125T
Brake, front/rear	SHIMANO, BR-MT420/BR-MT410	Hydraulic disc brake, 4-piston/2-piston
Brake lever, front/rear	SHIMANO, BL-MT402-3A	...
Disc, front	SHIMANO, SM-RT30	180 mm
Rim, front/rear	SCHÜRMANN, YAK Disc	...
Hub, front	SHIMANO, Alivio HB-4050	Front wheel freewheel hub
Hub, rear	SHIMANO, Nexus SG-C70000-5D	Gear hub, 5-speed
Spokes	SPOKE, 2.0 blk	...
Spoke nipples	#	#
Wheel set
Tyres	SCHWALBE, Marathon E-Plus	50-622
Tube	SCHWALBE, AV19	Schrader valve
Front lamp	FUXON, FF-100 EB	100 lx
Rear lamp	FUXON, R-Glow EB	...
Dynamo
Pannier rack	MONKEYLOAD, MonkeyLoad Carrier	MonkeyLoad system
Guards	SKS, Edge AL C56R	...
Chain guard	Kettler Quadriga	...
Lock
Stand	URSUS, Wave	

Motor	BOSCH, Performance Line CX, BDU3740	250 Watt, 85 Nm
Rechargeable battery	BOSCH, PowerTube 750, BBP3770	Horizontal, 750 Wh
On-board computer	BOSCH, LED Remote	With KIOX300 display
Charger	BOSCH, charger, BPC3400	4 A

...not available

Information not available when document was produced

11.3.2 QUADRIGA COMP CX11 750

KB184-xxKD, KB184-xxKT, KB184-xxKW

Frame material	...	Aluminium
Fork	SR Suntour XCM34-Boost	Deflection: 100 mm
Steering headset	FSA, 55R	1.5 inch
Handlebars	ZECURE	Handlebar width: 640 mm; handlebar angle: 15°
Handles	ERGON, GP3	...
Stem	ZECURE, UP2+	...
Saddle	COMODORO, M / XL	...
Seat post	LIMOTEC, A3Z suspension dropper post	80/120/140 × 34.9 mm
Saddle clamp	LIMOTEC	38.6 mm
Crank set	SAMOX	Crank length: 170 mm
Pedals	ZECURE, VP-469	...
Rear derailleur	SHIMANO, Deore SLX RD-M7100	12-gear
Shifter	SHIMANO, Deore SLX SL-M7100	...
Front derailleur
Cassette/cassette sprocket	SHIMANO, Deore SLX CS-M7100	10-51T
Chain	SHIMANO, Deore SLX CN-M7100	...
Toothed belt
Brake, front/rear	SHIMANO, BR-MT420/BR-MT410	Hydraulic disc brake, 4-piston/2-piston
Brake lever, front/rear	SHIMANO, BL-MT02-3A	...
Disc, front	SHIMANO, SM-RT30	180 mm
Rim, front/rear	RODI, TRYP30	...
Hub, front	SHIMANO, HB-MT400-B	Front wheel freewheel hub
Hub, rear	SHIMANO, FH-MT510-B	Freewheel hub
Spokes	SPOKE, 2.0 blk	...
Spoke nipples	#	#
Wheel set
Tyres	SCHWALBE, Smart Sam Plus Performance	57-584
Tube	SCHWALBE, AV19	Schrader valve
Front lamp	FUXON, FF-100 HB	100 lx
Rear lamp	FUXON, R-Glow EB	...
Dynamo
Pannier rack	MONKEYLOAD, MonkeyLoad Carrier	MonkeyLoad system
Guards	SKS, Edge AL C66R	...
Chain guard	Kettler Quadriga	...
Lock
Stand	URSUS, Wave	
Motor	BOSCH, Performance Line CX, BDU3740	250 Watt, 85 Nm
Rechargeable battery	BOSCH, PowerTube 750, BBP3770	Horizontal, 750 Wh

On-board computer	BOSCH, LED Remote	With KIOX300 display
Charger	BOSCH, charger, BPC3400	4 A

...not available

Information not available when document was produced

11.3.3 QUADRIGA PRO BELT AUTOMATIC

KB180-xxFD, KB180-xxFW

Frame material	...	Aluminium
Fork	SR Suntour Mobie25, Air	Deflection: 63 mm
Steering headset	All Up	1.5 inch
Handlebars	NOIR, Mtb	Handlebar width: 680 mm/660 mm; handlebar angle: 15°
Handles	VELO, VLG-649	...
Stem	SATORI, All Up	...
Saddle	COMODORO, M / XL	...
Seat post	LIMOTEC, A3Z suspension dropper post	80/120/140 × 34.9 mm
Saddle clamp	LIMOTEC	38.6 mm
Crank set	SAMOX	Crank length: 170 mm
Pedals	ZECURE, VP-658	...
Rear derailleur
Shifter	Automatig Controller Cliq Pro	...
Front derailleur
Cassette/cassette sprocket	GATES, CDXR22NU	...
Chain
Toothed belt	GATES, CDX	125T
Brake, front/rear	SHIMANO, Deore BR-M6000	Hydraulic disc brake, 2-piston
Brake lever, front/rear	SHIMANO, Deore BL-T6000	...
Disc, front	SHIMANO, SM-RT64 /SHIMANO, RT-66	180 mm
Rim, front/rear	SCHÜRMANN, YAK Disc	...
Hub, front	SHIMANO, Deore HB-M6010	Front wheel freewheel hub
Hub, rear	ENVILOLO, TRE	Gear hub, continuously variable
Spokes	SPOKE, 2.0 blk	...
Spoke nipples	#	#
Wheel set
Tyres	SCHWALBE, Marathon E-Plus	55-622
Tube	SCHWALBE, AV19	Schrader valve
Front lamp	FUXON, FF-100 EB	100 lx
Rear lamp	FUXON, R-Glow EB	...
Dynamo
Pannier rack	MONKEYLOAD, MonkeyLoad Carrier	MonkeyLoad system
Guards	SKS, Edge AL C66R	...
Chain guard	Kettler Quadriga	...
Lock
Stand	URSUS, Wave	...
Motor	BOSCH, Performance Line CX, BDU3740	250 Watt, 85 Nm

Rechargeable battery	BOSCH, PowerTube 750, BBP3770	Horizontal, 750 Wh
On-board computer	BOSCH, LED Remote	With KIOX300 display
Charger	BOSCH, charger, BPC3400	4 A

...not available

Information not available when document was produced

11.3.4 QUADRIGA PRO CX12 750

KB180-xxFD, KB180-xxFW

Frame material	...	Aluminium
Fork	SR Suntour Mobie25, Air	Deflection: 63 mm
Steering headset	All Up	1.5 inch
Handlebars	NOIR, Mtb	Handlebar width: 680 mm/660 mm; handlebar angle: 15°
Handles	ERGON, GP1	...
Stem	SATORI, All Up	...
Saddle	COMODORO, M /XL	...
Seat post	LIMOTEC, A3Z suspension dropper post	80/120/140 × 34.9 mm
Saddle clamp	LIMOTEC	38.6 mm
Crank set	SAMOX	Crank length: 170 mm
Pedals	ZECURE, VP-658	...
Rear derailleur	SHIMANO, Deore SLX RD-M7100	12-gear
Shifter	SHIMANO, Deore SL-M6100	...
Front derailleur
Cassette/cassette sprocket	SHIMANO, Deore SLX CS-M7100	10-51T
Chain	SHIMANO, Deore CN-M6100	...
Toothed belt
Brake, front/rear	SHIMANO, Deore XT BR-M8120/BR-M8100	Hydraulic disc brake, 4-piston/2-piston
Brake lever, front/rear	SHIMANO, Deore XT BL-T8100	...
Disc, front	SHIMANO, SM-RT64 /SHIMANO, RT-66	180 mm
Rim, front/rear	SCHÜRMANN, YAK Disc	...
Hub, front	SHIMANO, Deore HB-M6010	Front wheel freewheel hub
Hub, rear	SHIMANO, FH-MT500	Freewheel hub
Spokes	SPOKE, 2.0 blk	...
Spoke nipples	#	#
Wheel set
Tyres	SCHWALBE, Marathon E-Plus	55-622
Tube	SCHWALBE, AV19	Schrader valve
Front lamp	FUXON, FF-100 EB	100 lx
Rear lamp	FUXON, R-Glow EB	...
Dynamo
Pannier rack	MONKEYLOAD, MonkeyLoad Carrier	MonkeyLoad system
Guards	SKS, Edge AL C66R	...
Chain guard	Kettler Quadriga	...
Lock
Stand	URSUS, Wave	...
Motor	BOSCH, Performance Line CX, BDU3740	250 Watt, 85 Nm

Rechargeable battery	BOSCH, PowerTube 750, BBP3770	Horizontal, 750 Wh
On-board computer	BOSCH, LED Remote	With KIOX300 display
Charger	BOSCH, charger, BPC3400	4 A

...not available

Information not available when document was produced

11.3.5 QUADRIGA TOWN & COUNTRY COMP 750

KB183-xxKD, KB183-xxKW

Frame material	...	Aluminium
Fork	SR Suntour XCR34, Air	Deflection: 100 mm
Steering headset	All Up	1.5 inch
Handlebars	NOIR, Mtb	Handlebar width: 680 mm; handlebar angle: 15°
Handles	ERGON, GP3	...
Stem	SATORI, All Up	...
Saddle	COMODORO, M / XL	...
Seat post	LIMOTEC, A3Z suspension dropper post	80/120/140 × 34.9 mm
Saddle clamp	LIMOTEC	38.6 mm
Crank set	SAMOX	Crank length: 170 mm
Pedals	ZECURE, VP-469	...
Rear derailleur	SHIMANO, Deore XT RD-M8100	12-gear
Shifter	SHIMANO, Deore XT SL-M8100	...
Front derailleur
Cassette/cassette sprocket	SHIMANO, Deore SLX CS-M7100	10-51T
Chain	SHIMANO, Deore SLX CN-M7100	...
Toothed belt
Brake, front/rear	SHIMANO, Deore XT BR-M8120/BR-M8100	Hydraulic disc brake, 4-piston/2-piston
Brake lever, front/rear	SHIMANO, Deore XT BL-T8100	...
Disc, front	SHIMANO, SM-RT64 /SHIMANO, RT-66	180 mm
Rim, front/rear	RODI, TRYP30	...
Hub, front	SHIMANO, Deore SLX HB-M7110-B	Front wheel freewheel hub
Hub, rear	SHIMANO, Deore SLX FH-M7110-B	Freewheel hub
Spokes	SPOKE, 2.0 blk	...
Spoke nipples	#	#
Wheel set
Tyres	SCHWALBE, Smart Sam Plus Performance	57-584
Tube	SCHWALBE, AV19	Schrader valve
Front lamp	FUXON, FF-100 HB	100 lx
Rear lamp	FUXON, R-Glow EB	...
Dynamo
Pannier rack	MONKEYLOAD, MonkeyLoad Carrier	MonkeyLoad system
Guards	SKS, Edge AL C66R	...
Chain guard	Kettler Quadriga	...
Lock
Stand	URSUS, Wave	
Motor	BOSCH, Performance Line CX, BDU3740	250 Watt, 85 Nm
Rechargeable battery	BOSCH, PowerTube 750, BBP3770	Horizontal, 750 Wh

On-board computer	BOSCH, LED Remote	With KIOX300 display
Charger	BOSCH, charger, BPC3400	4 A

...not available

Information not available when document was produced

11.3.6 QUADRIGA TOWN & COUNTRY PRO 750

KB182-xxKD, KB182-xxKW

Frame material	...	Aluminium
Fork	SR Suntour XCR34, Air	Deflection: 100 mm
Steering headset	All Up	1.5 inch
Handlebars	NOIR, Mtb	Handlebar width: 680 mm; handlebar angle: 15°
Handles	ERGON, GP3	...
Stem	SATORI, All Up	...
Saddle	COMODORO, M / XL	...
Seat post	LIMOTEC, A3Z suspension dropper post	80/120/140 × 34.9 mm
Saddle clamp	LIMOTEC	38.6 mm
Crank set	SAMOX	Crank length: 170 mm
Pedals	ZECURE, VP-469	...
Rear derailleur	SHIMANO, Deore XT RD-M8100	12-gear
Shifter	SHIMANO, Deore XT SL-M8100	...
Front derailleur
Cassette/cassette sprocket	SHIMANO, Deore SLX CS-M7100	10-51T
Chain	SHIMANO, Deore SLX CN-M7100	...
Toothed belt
Brake, front/rear	SHIMANO, Deore XT BR-M8120/BR-M8100	Hydraulic disc brake, 4-piston/2-piston
Brake lever, front/rear	SHIMANO, Deore XT BL-T8100	...
Disc, front	SHIMANO, SM-RT64 /SHIMANO, RT-66	180 mm
Rim, front/rear	RODI, TRYP30	...
Hub, front	SHIMANO, Deore SLX HB-M7110-B	Front wheel freewheel hub
Hub, rear	SHIMANO, Deore SLX FH-M7110-B	Freewheel hub
Spokes	SPOKE, 2.0 blk	...
Spoke nipples	#	#
Wheel set
Tyres	SCHWALBE, Smart Sam Plus Performance	57-584
Tube	SCHWALBE, AV19	Schrader valve
Front lamp	FUXON, FF-100 HB	100 lx
Rear lamp	FUXON, R-Glow EB	...
Dynamo
Pannier rack	MONKEYLOAD, MonkeyLoad Carrier	MonkeyLoad system
Guards	SKS, Edge AL C66R	...
Chain guard	Kettler Quadriga	...
Lock
Stand	URSUS, Wave	
Motor	BOSCH, Performance Line CX, BDU3740	250 Watt, 85 Nm
Rechargeable battery	BOSCH, PowerTube 750, BBP3770	Horizontal, 750 Wh

On-board computer	BOSCH, LED Remote	With KIOX300 display
Charger	BOSCH, charger, BPC3400	4 A

...not available

Information not available when document was produced

11.4 Charger operating instructions



Charger

BPC3400

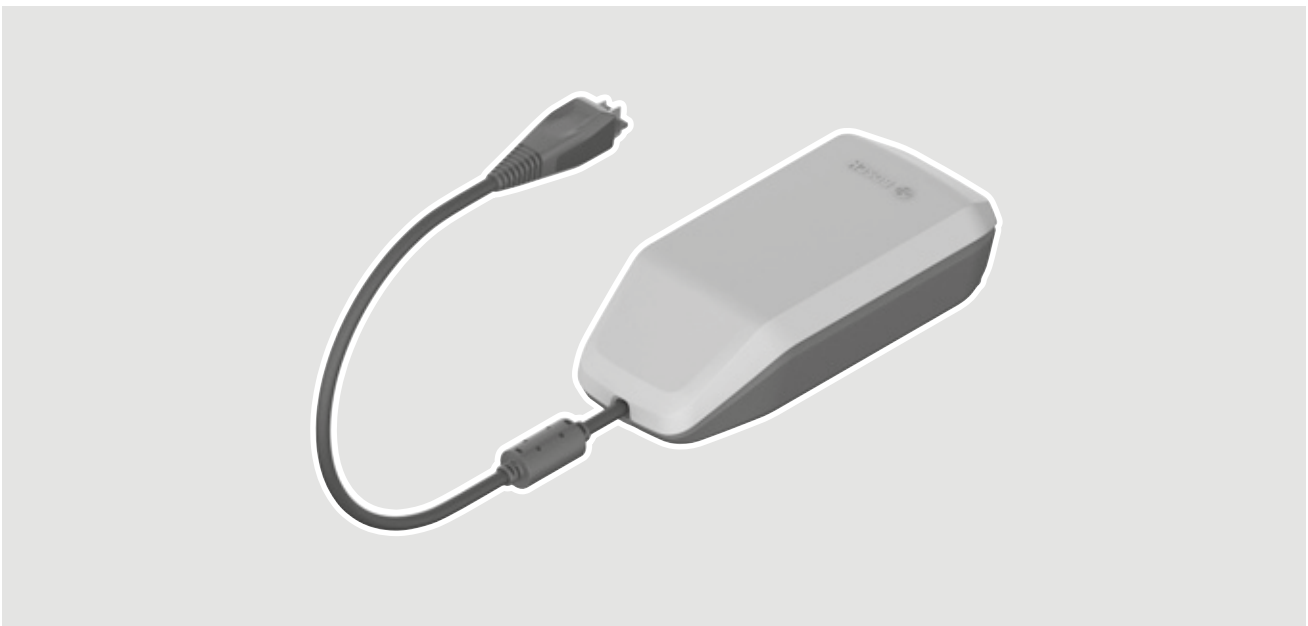

en Original operating instructions



2 |

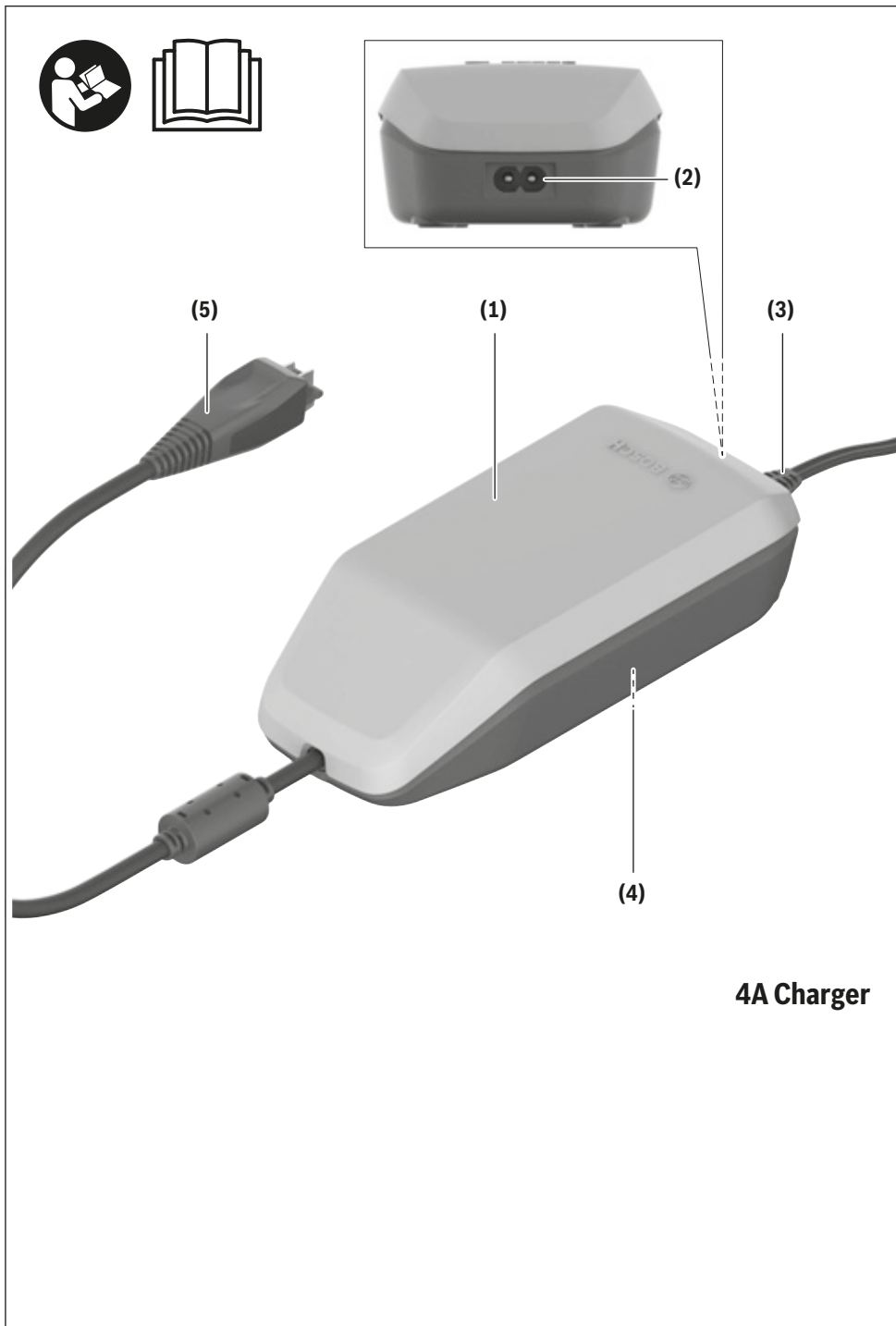

0 275 007 3CX | (09.06.2021)

Bosch eBike Systems

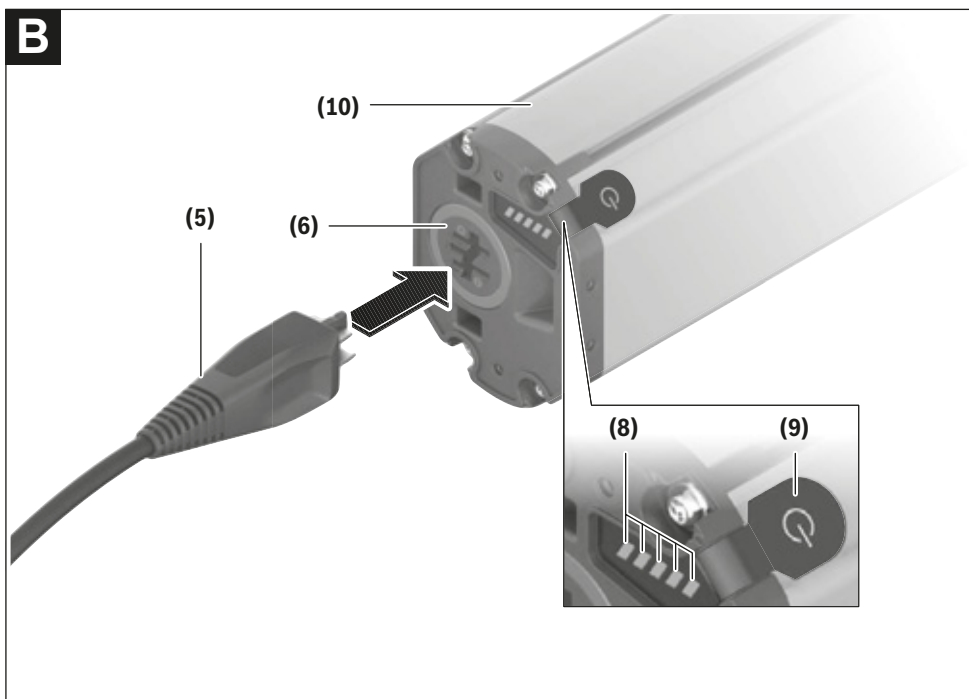
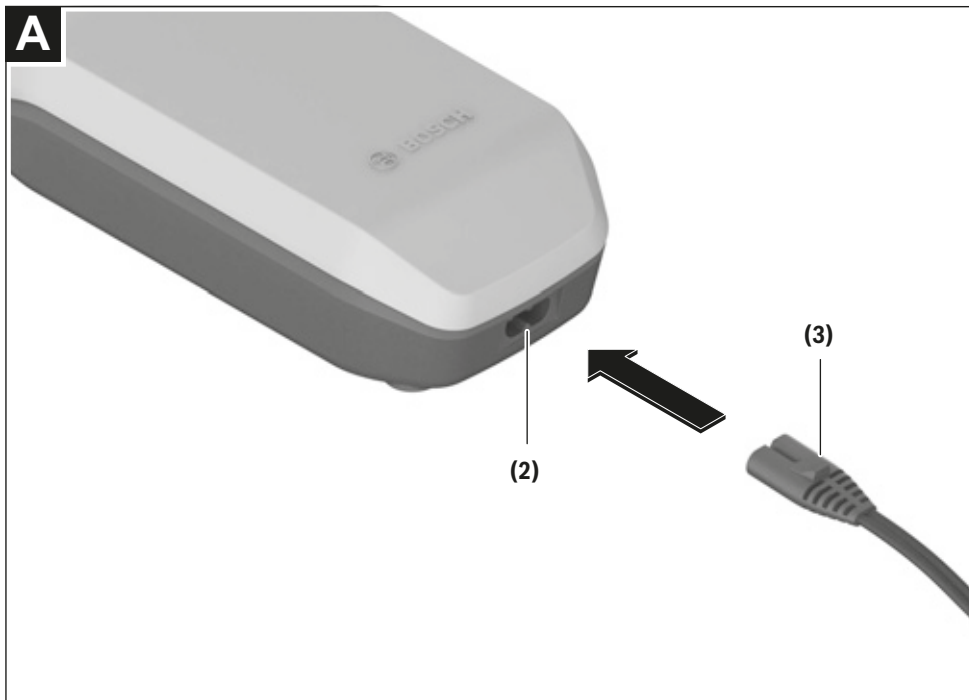

4 |

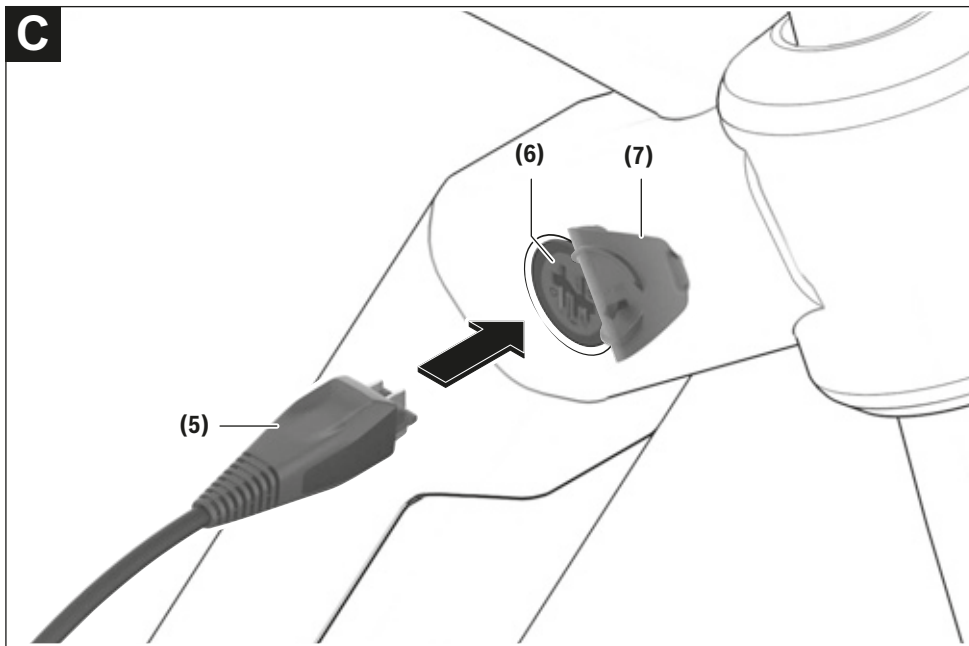

Safety instructions



Read all the safety and general instructions. Failure to observe the safety and general instructions may result in electric shock, fire and/or serious injury.

Save all safety warnings and instructions for future reference.

The term **battery** is used in these instructions to mean all original Bosch eBike rechargeable battery packs.



Do not expose the charger to rain or wet conditions. If water enters a charger, there is a risk of electric shock.

- ▶ **Charge only Bosch lithium-ion batteries that are approved for use in eBikes. The battery voltage must match the battery charging voltage of the charger.** Otherwise there is a danger of fire and explosion.
- ▶ **Keep the charger clean.** Dirt poses a risk of electric shock.
- ▶ **Always check the charger, cable and plug before use. Stop using the charger if you discover any damage. Do not open the charger.** Damaged chargers, cables and plugs increase the risk of electric shock.
- ▶ **Do not operate the charger on an easily ignited surface (e.g. paper, textiles, etc.) or in a flammable environment.** There is a risk of fire due to the charger heating up during operation.

onment. There is a risk of fire due to the charger heating up during operation.

- ▶ **Take care if you touch the charger while it is charging. Wear protective gloves.** The charger can get very hot, especially when the ambient temperature is high.
- ▶ **The battery may give off fumes if it becomes damaged or is used incorrectly. Ensure the area is well ventilated and seek medical attention should you experience any adverse effects.** The fumes may irritate the respiratory system.
- ▶ **The eBike battery must not be left unattended while charging.**
- ▶ **Supervise children during use, cleaning and maintenance.** This will ensure that children do not play with the charger.
- ▶ **Children or persons who, owing to their physical, sensory or mental limitations or to their lack of experience or knowledge, are not capable of safely operating the charger may only use this charger under supervision or after having been instructed by a responsible person.** Otherwise, there is a danger of operating errors and injuries.
- ▶ **Read and observe the safety warnings and directions contained in all the eBike system operating instructions and in the operating instructions of your eBike.**
- ▶ A sticker in English is adhered to the bottom of the charger (marked **(4)** in the diagram on the graphics page). This says:

Use ONLY with BOSCH lithium-ion rechargeable batteries!

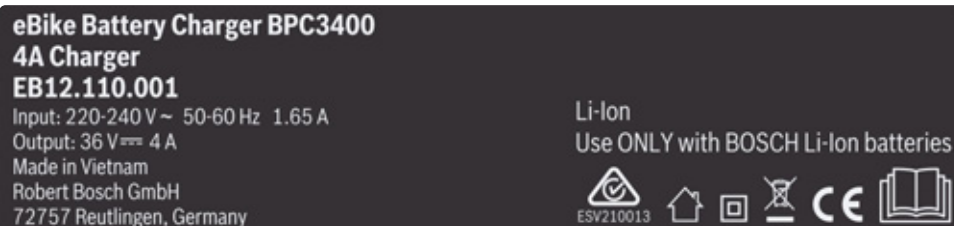

Product description and specifications

Intended Use

In addition to the functions shown here, changes to software relating to troubleshooting and functional modifications may be introduced at any time.

The Bosch eBike chargers are intended exclusively for charging Bosch eBike batteries and must not be used for any other purpose.

Product features

The numbering of the components shown refers to the illustrations on the graphics pages at the beginning of the manual.

Individual illustrations in these operating instructions may differ slightly from the actual conditions depending on the equipment of your eBike.

- (1) Battery charger
- (2) Device socket
- (3) Device connector
- (4) Charger safety instructions
- (5) Charging connector
- (6) Socket for charging connector
- (7) Charging socket cover
- (8) Operation/battery charge indicator
- (9) Battery on/off button
- (10) PowerTube

English – 2

Technical data

Charger	4A Charger	
Product code		BPC3400
Rated voltage	V~	198 to 264
Frequency	Hz	47 to 63
Battery charging voltage	V=	36
Charging current (max.)	A	4
Charging time for PowerTube 750, approx.	h	6
Operating temperature	°C	0 to 40
Storage temperature	°C	10 to 40
Weight, approx.	kg	0.7
Protection rating		IP40

The specifications apply to a rated voltage [U] of 230 V. These specifications may vary at different voltages and in country-specific models.

UK
CA

Operation

Start-up

Connecting the charger to the mains (see figure A)

- **Pay attention to the mains voltage.** The voltage of the power source must match the voltage specified on the rating plate of the charger. Chargers marked 230 V can also be operated at 220 V.

Plug the device connector (3) of the power cable into the device socket (2) on the charger.

Connect the power cable (country-specific) to the mains.

Charging the removed battery (see figure B)

Switch the battery off and remove it from its holder on the eBike. When doing so, read and observe the operating instructions of the battery.

- **Ensure the battery is placed on clean surfaces only.** Avoid getting dirt, e.g. sand or soil, in the charging socket and contacts in particular.

Plug the charging connector (5) of the charger into the socket (6) on the battery.

Charging the battery on the bike (see figure C)

Switch the battery off. Clean the cover of the charging socket (7). Avoid getting dirt, e.g. sand or soil, in the charging socket and contacts in particular.

Lift the cover of the charging socket (7) and plug the charging connector (5) into the charging socket (6).

- **There is a risk of fire due to the charger heating up during charging. Ensure the battery on the bike is completely dry and placed on a fireproof surface before charging.** If this is not possible, remove the battery from the holder and charge it in a more suitable location. When doing so, read and observe the operating instructions of the battery.

Charging process

The charging process begins as soon as the charger is connected to the battery or charging socket on the bike and to the mains.

Note: The charging process is only possible when the temperature of the eBike battery is within the permitted charging temperature range.

Note: The drive unit is deactivated during the charging process.

The battery can be charged with and without the on-board computer. When charging without the on-board computer, the charging procedure can be observed on the battery charge indicator.

When the on-board computer is connected, a charging notification appears on the display.

The state of charge is displayed by the battery charge indicator (8) on the battery and by the bars on the on-board computer.

The LEDs on the battery charge indicator (8) flash during the charging process. Each solid illuminated LED represents approximately 20 % of the charging capacity. The flashing LED indicates the next 20 % currently charging.

Once the eBike battery is fully charged, the LEDs go out immediately and the on-board computer is switched off. The charging process is terminated. The state of charge can be displayed for 5 seconds by pressing the on/off button (9) on the eBike battery.



Disconnect the charger from the mains and the battery from the charger.

When the battery is disconnected from the charger, the battery is automatically switched off.

Note: If you have charged the battery on the bike, carefully close the charging socket (6) with the cover (7) after charging, so that no dirt or water can get in.

If the charger is not disconnected from the battery after charging, after a few hours the charger will switch itself back on, check the state of charge of the battery and begin the charging procedure again if necessary.

Errors – causes and corrective measures

Cause	Corrective measures
 <p>Battery defective</p>	<p>Two LEDs flash on the battery.</p> <p>Contact an authorised bike dealership.</p>
 <p>Battery too warm or too cold</p>	<p>Three LEDs flash on the battery.</p> <p>Disconnect the battery from the charger until the charging temperature range has been reached.</p> <p>Do not reconnect the battery to the charger until it has reached the correct charging temperature.</p>
 <p>The charger is not charging.</p>	<p>No LEDs flashing (one or more LEDs will remain permanently lit depending on the state of charge of the eBike battery).</p> <p>Contact an authorised bike dealership.</p>
Charging not possible (no indicator on battery)	
Connector not attached properly	Check all connections.
Battery contacts dirty	Carefully clean the battery contacts.
Plug socket, cable or charger defective	Check the mains voltage, have the charger checked over by a bike dealership.
Battery defective	Contact an authorised bike dealership.

Maintenance and servicing

Maintenance and cleaning

If the charger fails, please contact an authorised bike dealership.

After-sales service and advice on using products

If you have any questions about the eBike system and its components, contact an authorised bicycle dealer.

For contact details of authorised bike dealerships, please visit www.bosch-ebike.com.

Disposal

Chargers, accessories and packaging should be recycled in an environmentally friendly manner.

Do not dispose of chargers along with household waste.

Only for EU countries:



According to the European Directive 2012/19/EU on Waste Electrical and Electronic Equipment and its implementation into national law, chargers that are no longer usable must be collected separately and disposed of in an environmentally friendly manner.

Subject to change without notice.

12 Glossary

Bicycle for young adults

Source: ISO 4210-2: pedelec designed for use on public roads by a young adult whose weight is less than 40 kg, with maximum saddle height of 635 mm or more and less than 750 mm (see ISO 4210).

Brake lever

Source: EN 15194:2017: lever used to apply the brake.

Braking distance

Source: EN 15194:2017: distance travelled by a pedelec between the commencement of braking and the point at which the pedelec comes to rest.

Cargo bike

Source: DIN 79010: pedelec mainly designed to carry goods.

CE marking

Source: Directive on Machinery: the manufacturer uses the CE marking to declare that the pedelec complies with the applicable requirements.

City and trekking bicycles

Source: EN-ISO 4210 - 2: pedelec designed for use on public roads primarily for means of transportation or leisure.

Consumables

Source: EN 82079-1: any part or material that is needed to continue using or maintain the product.

Continuous power rating

Source: ISO 15194:2017, output power specified by the manufacturer at which the motor reaches its thermal equilibrium under the specified ambient conditions.

Decommissioning

Source: DIN 31051: intentional, unlimited interruption in an object's functional capability.

Disc brake

Source: EN 15194:2017: brake in which brake pads are used to grip the lateral faces of a thin disc attached to or incorporated into the wheel hub.

Drive belt

Source: EN 15194:2017: seamless ring belt which is used as a means of transmitting drive force.

Electrical control system

Source: EN 15194:2017: electronic and/or electrical component or an assembly of components provided for installation into a vehicle, together with all electrical connections and associated wiring for the motor electrical power assistance.

Electrically power assisted pedelec, pedelec

Source: EN 15194:2017: electrically power assisted cycle pedelec EPAC bicycles, equipped with pedals and an auxiliary electric motor, which cannot be propelled exclusively by means of the auxiliary electric motor, except in start-up assistance mode.

Emergency stop

Source: ISO 13850:2015, function or signal, designed: — to avert arising or reduce existing hazards to persons, damage to machinery or to work in progress; – to be initiated by a single human action.

Fault

Source: EN 13306:2018-02, 6.1: state of an item (4.2.1) characterized by inability to perform a required function (4.5.1), excluding the inability during preventive maintenance or other planned actions, or due to lack of external resources.

Folding bicycle

Source: ISO 4210-2: pedelec designed to fold into a compact form, making it easy to transport and store.

Fork steerer

Source: EN 15194:2017: part of a fork that rotates around the steering axis of a pedelec frame head tube. It is normally connected to the fork crown or directly to the fork legs, and is normally the point of connection between the fork and the handlebar stem.

Fracture

Source: EN 15194:2017: unintentional separation into two or more parts.

Maintenance

Source: DIN 31051: maintenance is generally performed at regular intervals and often carried out by trained technical staff. This ensures a maximum service life and low wear and tear for the maintained items. Proper maintenance is often also a pre-requisite for providing a warranty.

Manufacturer

Source: Directive 2006/42/EC on Machinery, 17.05.2006 Any natural or legal person who designs and/or manufactures machinery or partly completed machinery covered by this Directive and is responsible for the conformity of the machinery or the partly completed machinery with this Directive with a view to its being placed on the market, under his own name or trademark or for his own use.

Maximum continuous power rating

Source: ZEG: the maximum continuous power rating is the maximum power for the electric motor output shaft during 30 minutes.

Maximum permitted total weight

Source: EN 15194:2017: weight of the fully assembled pedelec plus the rider and baggage, as specified by the manufacturer.

Maximum saddle height

Source: EN 15194:2017: vertical distance from the ground to the point where the top of the seat surface is intersected by the seat-post axis, measured with the saddle in a horizontal position and with the seat-post set to the minimum insertion-depth mark.

Maximum tyre pressure

Source: EN 15194:2017: maximum tyre pressure recommended by the tyre or rim manufacturer for a safe and efficient performance. If the rim and tyre both indicate a maximum tyre pressure, the maximum inflation pressure is the lower of the two pressures indicated.

Minimum insertion depth

Source: EN 15194:2017: mark indicating the minimum insertion depth of handlebar stem into fork steerer (fork stem) or seat post into frame.

Model year

Source: ZEG: the model year refers to the first production year that the series-manufactured pedelec was manufactured in the version in question and is not always identical with the year of manufacture. The year of manufacture may be before the model year in some cases. If no technical modifications are introduced to the series, production may continue of pedelecs from a previous model year.

Mountain bike

Source: ISO 4210 - 2: pedelec designed for use off-road on rough terrain, on public roads, and on public pathways, equipped with a suitably strengthened frame and other components, and, typically, with wide-section tyres with coarse tread patterns and a wide range of transmission gears.

Negative deflection

Negative deflection or sag is fork compression caused by body weight and gear (e.g. a backpack), their sitting position and the frame geometry.

Off-road rough terrain

Source: EN 15194:2017: rough gravel tracks, forest trails and other generally off-road tracks where tree roots and rocks are likely to be encountered.

Operating instructions

Source: ISO/DIS 20607:2018: part of the user information that machine manufacturers provide to machine operators; it contains guidance, instructions and tips related to the use of the machine in all its life cycle phases.

Placing on the market

Source: Directive 2006/42/EC on Machinery, 17.05.2006, Making available for the first time in the Community machinery or partly completed machinery with a view to distribution or use, whether for reward or free of charge.

Pressure point

Source: ZEG: the pressure point on a brake is the point on the brake lever where the brake disc and brake pads respond and the braking process is initiated.

Quick-release device, quick release

Source: EN 15194:2017: lever actuated mechanism that connects, retains or secures a wheel or any other component.

Racing bicycle

Source: ISO 4210-2: pedelec designed for amateur rides at high speed and for use on public roads having a control and steering assembly with multiple grip positions to provide an aerodynamic posture Bicycle multi-speed transmission system and a tyre width not greater than 28 mm with the fully assembled bicycle having a maximum mass of 12 kg.

Rebound

The rebound defines the speed at which the fork rebounds after being loaded.

Rechargeable battery, battery

Source: DIN 40729:1985-05: a rechargeable battery is an energy storage device that can store supplied electrical energy as chemical energy (charging) and release it as electrical energy when required (discharging).

Seat post

Source: EN 15194:2017: component that clamps the saddle (with a bolt or assembly) and connects it to the frame.

Serial number

Source – ZEG: each pedelec has an eight-digit type number which is used to specify the design model year, the type and the version.

Shut-off speed

Source: EN 15194:2017: speed reached, by the pedelec, at the moment the current has dropped to zero or to the no load current value.

Slippage

Source: DIN 75204-1:1992-05: the difference in relation to vehicle speed between the vehicle speed and the speed of its wheels at their circumference.

Spare part

Source: EN 13306:2018-02, 3.5: item intended to replace a corresponding item in order to retain or maintain the original required function of the item.

Suspension fork

Source: EN 15194:2017: front wheel fork incorporating controlled, axial flexibility to reduce the transmission of road-shocks to the rider.

Suspension frame

Source: EN 15194:2017: frame incorporating controlled, vertical flexibility to reduce the transmission of road-shocks to the rider.

Total deflection

Source: Benny Wilbers, Werner Koch: Neue Fahrwerkstechnik im Detail (New chassis technology in detail): The distance that the wheel travels between an unloaded and a loaded position is called total deflection. When at rest, the vehicle's mass is applied to the springs and reduces the total deflection by the *negative deflection* to the positive deflection.

Wear

Source: DIN 31051: reduction in useful life (4.3.4), caused by chemical and/or physical processes.

Weight of ready-to-ride pedelec

Source: ZEG: the indicated weight for a ready-to-ride pedelec refers to the weight of a pedelec at the time of sale. The weight of each additional accessory must be added to this weight

Wheel

Source: ISO 4210 - 2: unit or combination of hub, rim and spokes or disc, but excluding tyre assembly.

Work environment

Source: ISO 9000:2015: set of conditions under which work is performed.

Year of manufacture

Source: ZEG: the year of manufacture is the year in which the pedelec was manufactured. The production period is always from May to July the following year.

12.1 Abbreviations

ABS = anti-blocking system

ECP = electronic cell protection

12.2 Simplified terms

The following terms are used for better legibility:

Term	Meaning
Operating instructions	Original operating instructions
Damper	Rear frame damper
Specialist dealer	Bicycle specialist dealer
Motor	Drive motor, sub-system
Belt drive	Toothed belt drive

Table 53: Simplified terms

13 Appendix

I. Translation of the original EC/EU Declaration of Conformity

Manufacturer

KETTLER Alu-Rad GmbH
Longericher Str. 2
50739 Köln, Germany

Authorised representative for documentation*

Janine Otto
c/o ZEG Zweirad-Einkaufs-Genossenschaft eG
Longericher Strasse 2
50739 Köln, Germany

The machine, pedelec types:

KB180-lxxD	Quadriga Pro Belt Automatic, Diamant	City and trekking bicycle
KB180-lxxT	Quadriga Pro Belt Automatic, Trapez	City and trekking bicycle
KB180-lxxW	Quadriga Pro Belt Automatic, Wave	City and trekking bicycle
KB181-lxxD	Quadriga Pro CX12, Diamant	City and trekking bicycle
KB181-lxxT	Quadriga Pro CX12, Trapez	City and trekking bicycle
KB181-lxxW	Quadriga Pro CX12, Wave	City and trekking bicycle
KB182-lxxD	Quadriga Town & Country Pro, Diamant	City and trekking bicycle
KB182-lxxT	Quadriga Town & Country Pro, Trapez	City and trekking bicycle
KB182-lxxW	Quadriga Town & Country Pro, Wave	City and trekking bicycle
KB183-lxxD	Quadriga Town & Country COMP, Diamant	City and trekking bicycle
KB183-lxxT	Quadriga Town & Country COMP, Trapez	City and trekking bicycle
KB183-lxxW	Quadriga Town & Country COMP, Wave	City and trekking bicycle
KB184-lxxD	Quadriga Comp CX11, Diamant	City and trekking bicycle
KB184-lxxT	Quadriga Comp CX11, Trapez	City and trekking bicycle
KB184-lxxW	Quadriga Comp CX11, Wave	City and trekking bicycle
KB185-lxxD	Quadriga Comp Belt CX5, Diamant	City and trekking bicycle
KB185-lxxT	Quadriga Comp Belt CX5, Trapez	City and trekking bicycle
KB185-lxxW	Quadriga Comp Belt CX5, Wave	City and trekking bicycle

Year of manufacture 2021 and year of manufacture 2022, complies with the following applicable EU provisions:

- Machinery Directive 2006/42/EC
- RoHS Directive 2011/65/EU
- Electromagnetic Compatibility Directive 2014/30/EU.

The safety objectives in the Low Voltage Directive 2014/35/EU have been met in compliance with Appendix I, No. 1.5.1 of the Machinery Directive 2006/42/EC.

The following harmonised standards have been applied:

- ISO 20607:2018 Safety machinery – Instruction handbook – General drafting principles
- EN 15194:2017 Cycles – Electrically power assisted cycles – EPAC Bicycles

The following other technical standards have been applied:

- EN 11243:2016: Cycles – Pannier racks for bicycles – Requirements and test methods



Cologne, 19/04/2021

.....
Egbert Hageböck, Managing Director of KETTLER Alu-Rad GmbH

* Community member who is authorised to compile the technical documentation

II. Declaration of conformity with RED Directive

Robert Bosch GmbH, Bosch eBike Systems,
hereby declares that the LED Remote radio
system type complies with Directive 2014/53/EU.
The complete EU declaration of conformity is
available online at:

<https://www.ebike-connect.com/conformity>.

14 Keyword index

A

- Air valve, 31
- Articulated shaft,
 - caring for 137
- Axle, 31

B

- Basic cleaning 130
- Battery housing, 39
- Battery level indicator (battery), 39
- Battery, 38
 - checking, 59
 - cleaning, 130
 - disposing of, 196
 - remove, 110
 - shipping 56
 - transporting, 56
- Integrated battery, 39
- Technical data 51, 52
- Belt guard 16
- Belt pulley, 37
- Belt tension,
 - check 148
- Belt, 37
 - cleaning, 133
- Bike headset, see steering headset
- Bowden cable 34
- Brake cable, 34
- Brake calliper, 35
- Brake disc, 35
 - checking 144
 - cleaning, 133
- Brake lever
 - cleaning, 133
- Brake lever,
 - servicing, 138
- Brake lining, 35
- Brake, 34
 - checking brake cables 147
 - checking the brake disc 144
 - checking the pressure point 143
 - cleaning, 129
 - securing during transport 56
- Cable clip, 34
- Cover cap, 34
- hydraulic 34
- Insert pin, 34
- Knob, 34

- mechanical 34
- Union nut 34
- Break in operation, 57
 - carrying out, 57
 - preparing, 57
- Button,
 - Minus, 42, 101, 113
 - On-Off (battery) 39
 - Plus, 42, 101, 113
 - Push assist, 42, 101, 113

C

- Carbon seat post
 - servicing, 136
 - Cassette,
 - cleaning, 132
 - Chain guard
 - cleaning, 133
 - Chain guard, 16
 - Chain tension,
 - checking 148
 - Chain wheel, 37
 - Chain wheels,
 - cleaning, 132
 - Chain, 25, 37
 - cleaning, 133
 - maintaining, 140, 149
 - servicing, 137
 - Charger, 39
 - disposing of, 196
 - Chassis, 26
 - Child seat, 104
 - Clamping force,
 - Adjusting the quick releases, 63
 - Checking the quick releases, 63
 - Clock,
 - setting 102
 - Compression adjustment, 30
 - Compression damper, 31
 - Control panel,
 - cleaning, 130
 - Crown, 31
- ### D
- Dimensions, 55
 - Direction of travel, 37
 - Disc brake, 35
 - Drive system, 37
 - switching on, 101, 112, 113, 114
 - Electric, 38
 - mechanical 37

- Dust seal, 31

E

- eBike Flow,
 - registering, 44, 99
- Electrical cable,
 - checking 147
- Emergency stop system 17

F

- Factory settings,
 - resetting 103
- Fork end, 27, 31
- Fork leg 27
- Fork lock,
 - Position 41
- Fork steerer, 27, 31
- Fork, 27
 - cleaning, 131
 - Rigid fork 28
 - servicing, 129, 134
 - SR Suntour structure, 31
 - Suspension fork, 28
- Frame, 26
 - cleaning, 131
 - servicing, 129, 134
- Front derailleur,
 - cleaning, 132
- Front light, 38
- Front wheel brake, 35
 - braking, 116
- Front wheel, see Wheel

G

- Gear shift,
 - switching, 117, 120

H

- Handle,
 - servicing, 135
- Handlebars, 25, 27, 41
 - cleaning, 131
 - servicing, 135
- Handles,
 - cleaning, 131
- Headset, see steering headset
- Hub, 32
 - cleaning, 132
 - servicing, 136

I

- Initial commissioning, 59

J

- Jockey wheel,
 - caring for 137

K

- Kickstand,
 - cleaning, 131
 - servicing, 135

L

- Language,
 - selecting 102, 103
- Leather handle,
 - servicing, 135
- Leather handles,
 - cleaning, 131
- Leather saddle,
 - cleaning, 132
 - servicing, 136
- Level of assistance, 43, 45
 - selecting 115
 - selecting, 115
 - ECO, 43, 45
 - OFF, 43, 45
 - TOUR, 43, 45
 - TURBO, 43, 45
- Lockout,
 - Position 41

M

- Minimum insertion depth marking, 78
- Minus button, 42, 101, 113
- Motor cover 16
- Motor, 38
 - cleaning, 130
 - Technical data 51
- Mudguard 16
 - cleaning, 131
 - servicing, 135

O

- On-board computer, 40
 - attaching, 100
 - charging the battery, 113
 - cleaning, 130
 - removing 100
 - removing, 100
 - securing 100
- On-screen indicator, 105

P

- Pannier rack battery,
 - remove, 110
- Pannier rack, 25
 - changing, 109
 - cleaning, 131
 - servicing, 135
 - using, 108
- Patent seat post, 36
- Pedal, 37
 - cleaning, 129

- servicing, 137
- Pedelec,
 - shipping 56
 - transporting, 56
- Plus button, 42, 101, 113
- Push assist button, 42, 101, 113
- Push assist,
 - use 114
 - using, 114

Q

Q-Loc, 31

R

- Rear derailleur, 37
 - servicing, 137
- Rear light, 38
- Rear wheel brake, 35
- Rebound adjuster, 31
- Rebound damping 30
- Retainer guard, 39
- Riding light,
 - switching off 114
 - switching on 114
- Rim brake locking lever 34
- Rim, 32
 - servicing, 136

S

- Saddle, 25, 109
 - changing the saddle tilt, 77
 - changing the seat length, 79
 - cleaning, 131
 - determining the saddle height, 77, 79
 - using, 109

Sag,

- Position of setting wheel 41
- Setting wheel, 31

- Seat post, 25, 36
 - cleaning, 131
 - servicing, 136
- Securing hook, 39
- Settings,
 - changing 102

Shifter,

- cleaning, 132
- servicing, 137

- Spoke nipples, 33
 - servicing, 136

Spoke, 32

- Stanchion, 31
- Start screen, 101
- Steering headset 26
- Steering system, 26
- Stem, 26
 - checking 148

- cleaning, 131
- servicing, 135

- Suspension fork,
 - cleaning, 129
 - servicing, 129
- Suspension seat post, 36
 - cleaning, 129
 - servicing, 136
- Switching elements,
 - cleaning, 132

T

- Trailer, 105
- Transportation, 55
- Transporting, see Transportation
- Tyre pressure, 32
- Tyre size, 32
- Tyres, 32
 - checking 141
 - cleaning, 132
 - converting 106
 - Airless 106
 - Tubeless 106

U

- USB port,
 - use 113
 - using, 113

V

- Valve, 32
 - Dunlop valve, 33
 - Presta valve, 33
 - Schrader valve, 33
- Vehicle,
 - Technical data 51

W

- Weight,
 - Shipping weight, 55
 - Weight, 55
- Wheel, 32
 - installing, 62, 65
- Winter break, see Break in operation